

INTERNATIONAL MONETARY FUND

How Nations Become Fragile: An AI-Augmented Bird's-Eye View (with a Case Study of South Sudan)

Tohid Atashbar

WP/23/167

IMF Working Papers describe research in progress by the author(s) and are published to elicit comments and to encourage debate.

The views expressed in IMF Working Papers are those of the author(s) and do not necessarily represent the views of the IMF, its Executive Board, or IMF management.

**2023
AUG**



WORKING PAPER

IMF Working Paper¹
African Department

How Nations Become Fragile: An AI-Augmented Bird's-Eye View (with a Case Study of South Sudan)

Authorized for Distribution by **Niko Hobdari**

August 2023

IMF Working Papers describe research in progress by the author(s) and are published to elicit comments and to encourage debate. The views expressed in IMF Working Papers are those of the author(s) and do not necessarily represent the views of the IMF, its Executive Board, or IMF management.

ABSTRACT: In this study we introduce and apply a set of machine learning and artificial intelligence techniques to analyze multi-dimensional fragility-related data. Our analysis of the fragility data collected by the OECD for its States of Fragility index showed that the use of such techniques could provide further insights into the non-linear relationships and diverse drivers of state fragility, highlighting the importance of a nuanced and context-specific approach to understanding and addressing this multi-aspect issue. We also applied the methodology used in this paper to South Sudan, one of the most fragile countries in the world to analyze the dynamics behind the different aspects of fragility over time. The results could be used to improve the Fund's country engagement strategy (CES) and efforts at the country.

RECOMMENDED CITATION: T. Atashbar. 2023. "How Nations Become Fragile: An AI-Augmented Bird's-Eye View (with a Case Study of South Sudan)", IMF Working Papers, WP/23/167.

JEL Classification Numbers:	C63; C89; F51; F63; I39; P36
Keywords:	Fragile and Conflict-Affected States; Fragility Trap, Fragility Syndrome; Machine Learning; Artificial Intelligence
Author's E-Mail Address:	tatashbar@imf.org

¹ The author would like to thank Robert Zymek for his helpful comments and suggestions. The author would also like to thank Sampawende Jules Tapsoba, Harold Zavarce, John-Paul Fanning, Marta Spinella, and Tomohide Mineyama, for their valuable comments. I appreciate the help provided by Niko Hobdari, Ron Yamada, Sunwoo Lee, and Tara Muehlschlegel of the IMF South Sudan Team. Special thanks to the Macro Policy division in the SPR for the continuous support. All errors are mine.

WORKING PAPERS

How Nations Become Fragile: An AI-Augmented Bird's-Eye View (with a Case Study of South Sudan)

Prepared by Tohid Atashbar

Contents

GLOSSARY	4
INTRODUCTION	5
I. FRAGILITY: A DIVE INTO THE LITERATURE	6
A. Definition(s) of Fragility	6
B. Drivers of Fragility	8
C. Mitigating Fragility.....	9
II. MEASURING FRAGILITY	10
A. Fragile States Index.....	10
B. States of Fragility	10
C. Country Policy and Institutional Assessment.....	12
D. Other Measures.....	13
III. AI TECHNIQUES TO EXPLORE FRAGILITY-RELATED DATA	14
A. Why Use AI and Machine Learning When Traditional Approaches Are Available?	14
B. AI Techniques for Classification and Dimension Reduction.....	15
C. Application to OECD Data.....	18
IV. THE CASE OF SOUTH SUDAN	26
A. History and Background	26
B. Pillars of the Fund's South Sudan CES to Tackle Fragility.....	26
C. Findings from this Analysis	27
D. Implications from this Study to the Fund's South Sudan CES.....	29
V. SUMMARY AND POLICY DISCUSSION	30
REFERENCES	31
FIGURES	
Figure 1. Syndrome of Fragility	9
Figure 2. OECD's States of Fragility.....	11
Figure 3. RNN vs LSTM Architecture	18
Figure 4. Fragility in Syria in the last decade.....	20
Figure 5. Different aspects of fragility in Syria in the Last Decade	21
Figure 6. Fluctuation of Aggregate Fragility in Haiti and Senegal	21
Figure 7. Fluctuation of Fragility Dimensions in Haiti and Senegal.....	22
Figure 8. Box Plot of Aggregate Fragility in 2021	23
Figure 9. Box Plot of Dimensional Fragilities in 2021	23
Figure 10. Most Environmentally-Fragile Countries in 2021	24
Figure 11. Box Plot of Aggregate Fragility 2010–2021	24
Figure 12. Box Plot of Economic Fragility 2010–2021	25
Figure 13. Box Plot of Environmental Fragility 2010–2021.....	25

Figure 14. Aggregate Fragility in South Sudan Over Time.....	27
Figure 15. Various Aspects of Fragility in South Sudan Over Time.....	27
Figure 16. Heatmap of Correlation of Dimensional Fragilities for South Sudan in 2021.....	28
Figure 17. Risk and Coping Political Fragility Sub-Indicators for South Sudan.....	28

TABLES

Table 1. Definitions of fragile states by various international organizations.....	7
Table 2. Indicators of the Fragile States Index.....	10
Table 3. CPIA Criteria.....	12
Table 4. A Sample Data from OECD's Fragility Dataset.....	19
Table 5. Most Fragile Countries (2010–2021).....	22

Glossary

AI	Artificial Intelligence
ANN	Artificial Neural Networks
CAST	Conflict Assessment Framework
CES	Country Engagement Strategy
CNN	Convolutional Neural Networks
CPIA	Country Policy and Institutional Assessment
FCS	Fragile and Conflict-Affected States
FSI	Failed States Index
FSI	Fragile States Index
IDA	International Development Association
ISW	Index of State Weakness
KNNs	K-Nearest Neighbors
KPCA	Kernel Principal Component Analysis
LDA	Latent Dirichlet Allocation
LSTM	Long Short-Term Memory Networks
ML	Machine Learning
NLPCA	Non-Linear Principal Component Analysis
NMF	Non-Negative Matrix Factorization
OECD	Organization for Economic Co-operation and Development
PCA	Principal Component Analysis
RNN	Recurrent Neural Networks
SVC	Support Vector Clustering
SVM	Support Vector Machines

Introduction

Fragility and conflict pose significant challenges for IMF members, as they can undermine macroeconomic stability and hinder resource development. Fragile states are typically unable to provide basic services to their citizens, have poor and ineffective government and are susceptible to internal and external shocks. The IMF assists its Fragile and Conflict-Affected States (FCS) members in achieving macroeconomic stability, promoting inclusive economic growth, and strengthening resilience through a tailored approach for fragile states like South Sudan. Focusing on providing customized policy advice, financial assistance, and capacity building, the IMF's FCS Strategy also fosters collaboration with international humanitarian, development, peace, and security organizations to ensure a comprehensive response. IMF teams use tailored Country Engagement Strategies (CES) to implement the Fund's mandate in FCSs, ensuring targeted and harmonized efforts adapted to the specific needs and challenges faced by each country.

Fragility is a multifaceted concept. It could be influenced by different factors. These causes could be related to political, economic, social and physical environment. It is also essential to recognize that fragility could be a concern not only for LIC or EMDEs, but also in developed economies. In fact, many of the world's wealthiest nations could be partially fragile or vulnerable due to environmental issues, aging populations, inequality, and other causes. "Advanced-Fragile" countries could be characterized by fragility in one or a few dimensions (e.g., social or environmental) notwithstanding their high-income status and generally robust institutions.

In order to address complex and multicausal nature of state fragility, it is essential to develop more sophisticated measures that could accurately capture different factors contributing to fragility. By using advanced tools like artificial intelligence and machine learning algorithms, the IMF staff and authorities can develop a deeper understanding of driving forces behind state fragility, leading to more targeted solutions. This paper seeks to address the gaps in the understanding of state fragility by proposing the use of more sophisticated analytic methods. Specifically, the paper aims to provide a comprehensive analysis of state fragility employing AI and machine learning techniques and consequently provide not only a multidimensional view of state fragility but also context-specific insights on the drivers of fragility. In doing so, the paper attempts to respond to the central question: "How can advanced methods such as AI and machine learning contribute to a more nuanced understanding of state fragility and consequently aid in the design of targeted interventions?"

As part of its policy messages, the paper argues that compared to the current methodologies, policymakers and other stakeholders could more effectively assess the complex nature of state fragility when creating interventions to reduce its effects. The paper underscores the crucial requirement of comprehending the unique characteristics of fragility that prominently exist within a certain context, and directing interventions in those areas. It highlights the fact that these elements are not always straightforward and might often present themselves in complex, non-linear forms. These non-linear configurations denote that they do not respond proportionally or predictably to interventions, further complicating the task. Moreover, it accentuates the intricate interconnections among these characteristics of fragility. Thus, understanding the intricacies of these intertwined, nonlinear facets of fragility is paramount in designing effective intervention strategies. Using South Sudan as an example, the paper illustrates the potential of AI and machine learning in doing this and consequently points to the possibility of designing more context-specific and effective interventions to address fragility.

This paper begins by reviewing economic literature on fragility and its causes and effects. It focuses on Fragility as a syndrome rather than a single factor phenomenon and investigates several facets of fragility as well as how they interact and influence one another. Second section of study examines various approaches to measuring fragility such as the World Bank's classification, OECD's States of Fragility Index, the Fragile States Index (FSI) and other metrics.

The third portion of the paper will focus on the application of AI-assisted methodologies to produce a big picture of fragility trends. This section will try to examine fragility trends and classify countries based on an analysis of fragility indicators using machine learning algorithms. They include Recurrent Neural Networks for processing sequential data, Support Vector Machines for classification tasks, and Kernel PCA for nonlinear dimensionality reduction. Input data for the analysis includes a comprehensive dataset of fragility-related risk and coping indicators, collected by OECD (States of Fragility 2022) for all nations.

The fourth section of paper will discuss fragility in South Sudan which is recognized as one of the most fragile nations in the world. First, a brief history and context of South Sudan will be presented. Then the paper will attempt to analyze causes and trends of fragility in South Sudan using the results produced in third section of the study and finally it will explore how to address the country's fragility in a more systematic way.

The paper will conclude with a summary of the analysis. In addition, ramifications for policymakers and other stakeholders will be discussed. We hope that the paper's findings will aid in the advancement of more effective strategy that may be used to address fragility and create resilience in fragile states as well as in a broader understanding of the fragility landscape and the numerous causes of fragility.

I. Fragility: A Dive Into the Literature

A. Definition(s) of Fragility

Despite the absence of consensus on what the term "fragility" entails, it frequently refers to a state that has problems with governance, capability, and sometimes inadequate state legitimacy, which frequently results in tensions and violent conflict (Diallo et al., 2022). Fragile and conflict-affected states (FCS) countries that are "trapped" in cycles of low administrative capability, political instability, conflict, and poor economic performance (IMF, 2015).

While there are numerous approaches to characterize fragile countries in the literature, reflecting their complexities, they appear to share some traits (IMF, 2008). They include: i) significant institutional and policy implementation limitations; (ii) a turbulent political backdrop; (iii) severe domestic resource limits; and (iv) high vulnerability to shocks (e.g., IMF, 2012).

Yet, there is no commonly agreed operational definition of "fragility". In the most academic research (in Akanbi et al, 2021), states are considered fragile when their limited institutional capability, political instability, and bad governance significantly impair the state's ability to guarantee security to its population and supply basic public services. For example, Collier (2021) proposes the following characteristics of a fragile state: little or no broad shared identity, lack of governmental legitimacy, lack of capacity, existential uncertainties, underdeveloped private sector, and significant exposure to political and economic shocks. Acemoglu and Robinson (2021) identify a fragile state based on its capabilities and political regime. Limited political and institutional capacity to implement appropriate policies to address structural challenges and exogenous shocks has resulted in poor economic performance, chronic humanitarian crises, persistent social tensions, and, in many cases, violence or the legacy of armed conflicts in fragile states.

The multifaceted and diverse nature of state fragility has worked against a clear definition of FCS, with numerous definitions employed by different institutions and experts (Table 1).

Table 1. Definitions of Fragile States by Various International Organizations²

African Development Bank	Countries or situations with unique development challenges that have resulted from fragility and conflict including weak institutional capacities and poor governance, economic and geographic isolation, economic disruption, social disruption and insecurity.
UK Government	DFID ³ (now merged with UK foreign ministry) used a broad definition (“Where the government cannot or will not deliver core functions to the majority of its people, including the poor.”) but also refers to a combination of the three widely accepted assessment frameworks: World Bank’s CPIA-indicators, the Fund for Peace’s Failed States Index (FSI) and the Uppsala Conflict Database.
European Union	Fragility refers to weak or failing structures and to situations where the social contract is broken due to the state’s incapacity or unwillingness to deal with its basic functions, meets its obligations and responsibilities regarding service delivery, management of resources, rule of law, equitable access to power, security and safety of the populace and protection and promotion of citizens’ rights and freedoms.
G7+	[A] state of fragility can be understood as a period of time during nationhood when sustainable socio-economic development requires greater emphasis on complementary peacebuilding and State-building activities such as building inclusive political settlements, security, justice, jobs, good management of resources, and accountable and fair service delivery.
Organization for Economic Co-operation and Development (OECD)	Pockets of fragility may occur at a subnational level, making it hard to keep the fragile states terminology. The States of fragility report 2015 marks a change towards defining dimensions of fragility: violence, justice, institutions, economic foundations and resilience. Thus, the OECD breaks down the drivers of fragility for each country and reveals different patterns of vulnerability instead of trying to stringently define fragility.
Swiss Agency for Development and Cooperation (SDC)	A state or context is describe as fragile if a significant proportion of the population does not regard the state as the legitimate framework for the exercise of power, if the state does not or cannot exercise its monopoly of the legitimate use of force within its territory, and if the state is unable or unwilling to provide basic goods and services to a significant part of the population.
United States Agency for International Development (USAID)	Fragile states refer to a broad range of failing, failed, and recovering states that are unable or unwilling to adequately assure the provision of security and basic services to a significant portion of their populations and where the legitimacy of the governments is in question. USAID distinguishes between fragile states that are vulnerable from those that are already in crisis.

In the World Bank (WB)/IMF quantitative methodology⁴, a country is in the situation of fragility if it has CPIA⁵ score for IDA⁶ countries that is below 3.0 or presence of a UN peacekeeping operation or flight across borders of 2,000 or more per 100,000 population from the origin country. In this methodology, a country is in conflict if it has ongoing conflict with a significant number of conflict deaths or if there is a rapid deterioration of the security situation with a substantial increase in casualties. (for details see Section II. C) The WB’s FCS list also includes only IDA eligible countries and non-member or inactive territories or countries without CPIA data.

² by [ILO \(2016\)](#)

³ Department for International Development

⁴ <https://www.worldbank.org/en/topic/fragilityconflictviolence/brief/harmonized-list-of-fragile-situations>

⁵ Country Policy and Institutional Assessment

⁶ International Development Association (IDA)

B. Drivers of Fragility

State fragility is a complex and multifaceted phenomenon that can have devastating consequences. It is caused by and can also result in a combination of internal and external factors, including weak governance, corruption, poverty, inequality, conflict and violence, international interventions, economic shocks, climate conditions, fragility of international economic systems, spread of extremist ideologies, erosion of social cohesion and many other interrelated factors.

Weak governance and corruption have been cited among the primary causes of fragility. Poor governance and the lack of accountability and transparency create an environment in which corruption can thrive leading to the misallocation of resources and the perpetuation of poverty and inequality. Vallings and Moreno-Torres (2005) found that poor institutions influence state fragility more than economic reasons. Political identity fragmentation and inadequate national institutions reinforce each other in fragile nations, according to Kaplan (2008). Three factors—political instability and violence, insecure property rights and unenforceable contracts, and corruption—create a slow-growth-poor-governance equilibrium, according to Andrimihaja et al. (2011). Income and economic growth affect state fragility, according to Feeny et al. (2015). Poorer countries are more fragile than affluent ones, and trade-open countries are less unstable (Carment et al., 2008, 2011). Country size and ethnic risk/diversity (Feeny et al., 2015) also affect fragility. State fragility is also linked to socioeconomic variables including poor HDI, increased infant mortality, and lower schooling (Feeny et al., 2015; Carment et al., 2008, 2011) (all in Akanbi et al., 2021).

Whatever the initial cause, fragile states are frequently constrained by a *syndrome* (Collier in IGC, 2018) of interconnected traits that makes it challenging to pursue long-term growth. Fragile societies frequently split into factions with opposing identities and view conflict as a zero-sum game. This makes it more difficult for different groups to work together to employ the state for common good. Instead, it fosters the mentality known as "our turn to eat," where the state is seen as a resource that can be plundered if the group can only seize control of it. Different studies have explored the conditions that lead to fragility traps, proposing theories such as the theory of endogenous fiscal capacity (Besley and Persson, 2013; Besley and Mueller, 2020), the long route of accountability (WB, 2004; Milante and Woolcock, 2017), the Civic culture hypothesis (Collier 2020, Bisin and Verdier, 2017), and the Red Queen theory (Acemoglu and Robinson, 2019 and 2020) in Chami and Espinoza (2021).

A fragile state often includes six defining qualities (Collier in Chami et al. 2021). First, there is little to no broad shared identity in the community, which may help put disagreements in the framework of cooperation. Instead, there are several oppositional identities. Second, a sizable portion of the state's own population do not view it as legitimate. Third, the state is unable to carry out fundamental duties including taxation, security, upholding the law, and maintaining economic infrastructure. Fourth, existential uncertainty shortens horizons and discourages irreversible decisions in households and firms. Fifth, because there aren't many formal private sector businesses, people aren't structured into groups that can benefit from economies of scale and specialization, which makes the populace unproductive and, thus, poor. Finally, the economy and politics are frequently subject to shocks against which they are vulnerable.

Figure 1. Syndrome of Fragility

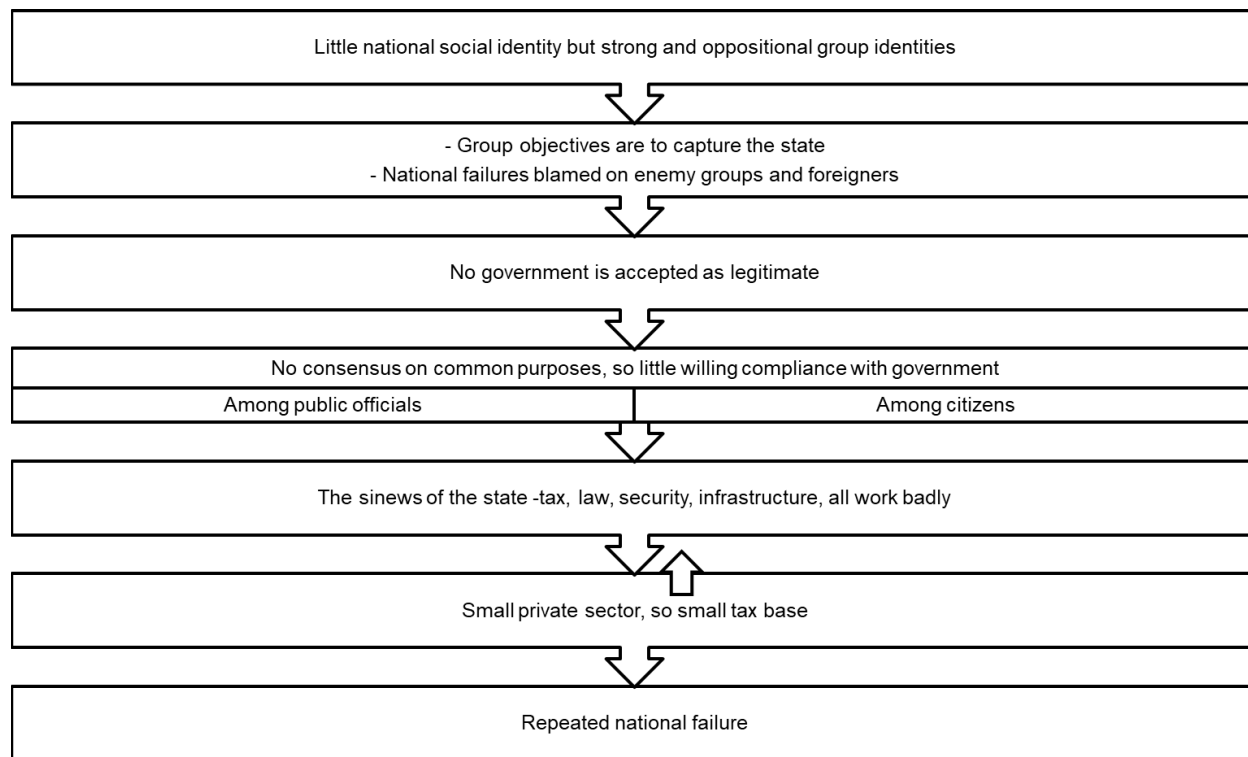

Source: (Collier, 2020)

C. Mitigating Fragility

The transition from fragility to resilience in FCS can be achieved by making mutually reinforcing improvements in both capacity and governance stressors, while also taking into account the link between macroeconomic stability and fragility. This will move service delivery from humanitarian relief to sustainable development (Dia, 2022). However, due to the fact that most FCS need to address a number of stressors relating to poor service delivery, low capacity, and high-risk governance, prioritization is necessary to help start with the most impactful and positive externalities. This transition process will not be a linear one, as progress in improving the capacity and governance stressors may not be equal.

Given the heterogeneity of fragile countries, there is no one-size-fits-all approach to addressing fragility. However, case studies have proven useful in understanding the specific policies that can be used to address fragility, fragility traps and fragility turning point (entry into and exit from points from fragility) (Akanbi et al., 2021; Bizhan, 2023). Enhancing the capacity to mobilize revenues more efficiently and strengthening control in budget and financial management have been found to help countries exit fragility. Fiscal institutions and fiscal space have also been found to be significantly and robustly associated with building resilience. Capacity building is also essential in addressing fragility, however, its effectiveness can be hindered by absorptive capacity constraints. To ensure its effectiveness, the use of on-the-ground experts, the employment of realistic impact assessment tools, and the securing of adequate financial resources for capacity building should be increased. Finally, strengthening legitimate institutions and governance to provide citizen security, justice, and jobs has been identified as a crucial factor in breaking cycles of violence and restoring a stable development path in fragile countries. Such an approach should integrate the roles of policy advice, financial support, and capacity building (IMF, 2011, 2015; IMF IEO, 2018).

The IMF has recently released its first Fragile and Conflict Affected States (FCS) Strategy (IMF, 2022). This strategy has been developed to provide extended and tailored support to help these countries attain

macroeconomic stability, bolster their resilience and foster sustainable and equitable growth. It also emphasizes the need to collaborate with international humanitarian, development, peace, and security organizations.

II. Measuring Fragility

While there is no single measure of fragility, there are a number of indices that have been developed to quantify the level of fragility in a given nation. This section provides an overview of some of the most commonly used indices for measuring fragility, including the Fund for Peace's Fragile States Index, OECD's States of Fragility, the World Bank's CPIA, and the State Fragility Index (SFI) produced by the Center for Systemic Peace.

A. Fragile States Index

The Fragile States Index (FSI) is an annual ranking created by the Fund for Peace (FFP) to measure the stability of a country's society, economy, and political environment. It is designed to provide an objective measure of a country's level of fragility, which could be used as an early warning system to identify states in danger of entering a period of crisis.

The Fragile States Index is based on a conflict assessment framework – known as "CAST" – that was established by FFP about a quarter-century ago to assess the state's susceptibility to collapse. The CAST framework was first developed to examine this vulnerability and its potential impact on field initiatives, and it continues to be widely utilized by policymakers, field practitioners, and local community networks. The methodology employs both qualitative and quantitative indicators, relies on data from public sources, and yields measurable outcomes.

There are twelve conflict risk indicators used to measure the current state of a country. These indicators are grouped into 4 categories: Cohesion, Economic, Political, Social. Each of the 12 main indicators of the index is ranked between 0 (best) to 10 (worst) which are normalized and aggregated to create the final composite index. The indicators give a time snapshot that may be compared to other time snapshots in a time series to assess if circumstances are improving or deteriorating. The list of indicators are in Table 2.

Table 2. Indicators of the Fragile States Index

Group	Cohesion	Economic	Political	Social
Components	C1: Security Apparatus C2: Factionalized Elites C3: Group Grievance	E1: Economic Decline E2: Uneven Economic Development E3: Human Flight and Brain Drain	P1: State Legitimacy P2: Public Services P3: Human Rights and Rule of Law	S1: Demographic Pressures S2: Refugees and IDPs X1: External Intervention

The FSI covers 178 countries and territories around the world. It is updated annually, with data from a variety of sources including the World Bank, UN agencies, and NGOs. The FSI also includes an interactive map that allows users to explore the data in greater detail, as well as a comprehensive list of resources on fragile states.

B. States of Fragility

The OECD's States of Fragility is a global index that measures the levels of fragility in a range of countries. Unlike the FSI, the States of Fragility does not provide a single score, but rather a set of indicators that

measure the fragility of a country on different dimensions. The OECD defines fragility as the combination of risk exposure and inadequate capacity of the state, systems, and/or communities to manage, absorb, or mitigate those risks.

According to OECD methodology, fragility is quantified on a scale of intensity and expressed differently across economic, environmental, political, security, human, and societal dimensions. Each component is covered by eight to twelve indicators, for a total of forty-four indicators across all five dimensions that quantify fragility-related risks and coping (which explains the resiliency part of the fragility). In doing so, the OECD multidimensional fragility framework captures the junction of fragility, risk, and resilience to identify where and how international actors may assist in addressing the core causes of fragility in each dimension while strengthening sources of resilience. Introduced in the 2016 edition of States of Fragility, the OECD's multidimensional fragility approach analyzes fragility on a scale of severity across six dimensions: economic, environmental, human, political, security, and societal.

It employs a mixed-methods approach that evaluates situations within each dimension before aggregating this data to generate an overall picture of fragility. The methodology is based on a two-stage principal components analysis (PCA) and a hierarchical clustering procedure to group contexts based on similar traits within each dimension. The States of Fragility platform has 57 indicators drawn from independent third-party data sources. Each of the six dimensions contains nine to ten indicators that are aggregated into principle components in the first stage of principal component analysis; the first two principal components in each dimension are utilized for the second stage of principal component analysis. The first principal component resulting from this second-stage PCA is the context's overall fragility score.

A context is defined as fragile if its score falls below -1.20 or as highly fragile if it falls below -2.85. The analysis (OECD States of Fragility in 2022 for the 2021 data cutoff) evaluates the fragility of 176 contexts (countries) for which sufficient data are available, defined as data for at least 70 percent of indicators being accessible for a context (Figure 2).

Figure 2. OECD's States of Fragility

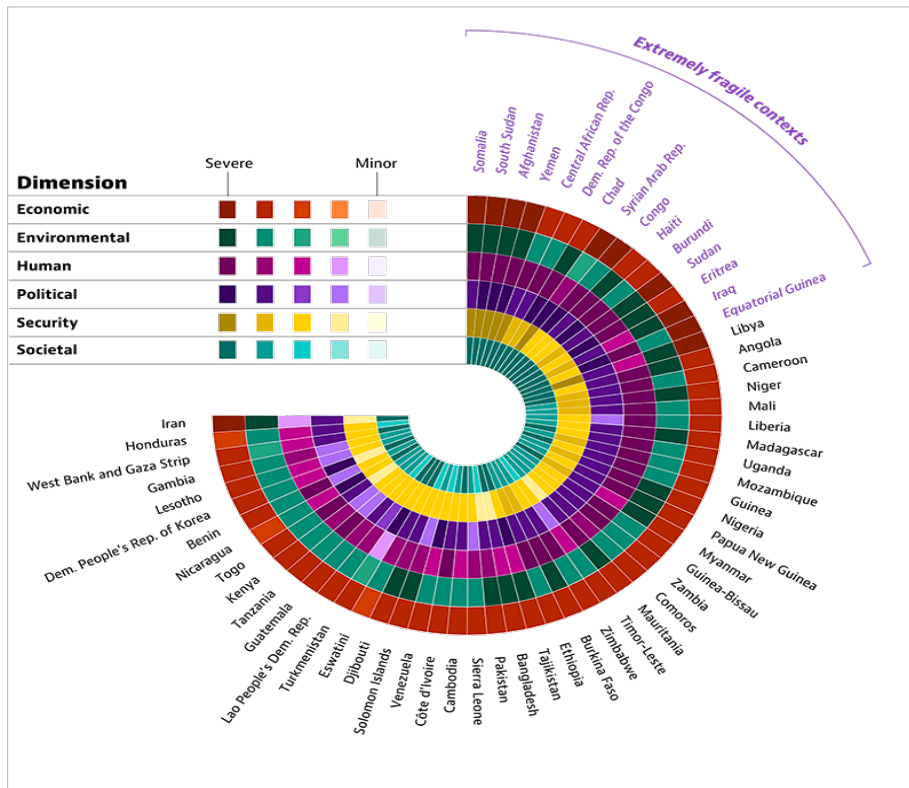

Source: (OECD, 2022)

The majority of the variance in the original data can be explained by reducing the range of indicators to two core components using principal component analysis (PCA). Nonetheless, invariably information is lost in the process. This information loss is exacerbated by the second stage of PCA (PCA Stage 2). Basically, the findings of this method are a summary of the original indicators, which is afterwards interpreted in terms of fragility. Notwithstanding these restrictions, according to methodology notes of the project⁷, the summary produced in this method is more informative and less arbitrary than other indices derived from the original indicators.

C. Country Policy and Institutional Assessment

As discussed in the previous sections, CPIA is a key metric used by the World Bank and IMF to categorize countries as fragile. The World Bank and other partner organizations utilize CPIA to determine amount of aid and financing that a country can receive. It is also used to assess outcomes of policy and aid interventions. The CPIA is a diagnostic tool designed to assess the effectiveness of a country's institutional policies and structures; as a result, it places more emphasis on important variables under the country's control than on outcomes (such growth rates), which are influenced by factors outside its control.

Additionally the CPIA assesses the degree to which a country's institutional and policy structure promotes poverty reduction and sustainable growth and as a result, the efficient use of development aid. The exercise's results include both an overall score and scores for each of the CPIA's sixteen categories. The CPIA tool was created and used for the first time in mid-1970s and over time the World Bank has periodically updated and enhanced it to reflect lessons learned from experience and the advancement of development-related research.

The 16 CPIA criteria are divided into four equally weighted clusters: Economic Management, Structural Policies, Policies for Social Inclusion and Equity and Public Sector Management and Institutions (Table 3). Countries are scored on a scale of 1 (low) to 6 for each of the 16 categories (high). The scores are determined by the level of performance in a given year measured against the criteria, rather than by improvements over the prior year. Instead of relying on intentions or promises, the evaluations are based on actual policies and performance. The Bank has created advice for each of the criteria, including a definition of each criterion and a thorough explanation of each rating level, to assist its staff in evaluating the performance of the country. The ranking is determined by the bank staff's evaluation of the country's actual performance on each of the criteria. Both the cluster score and the composite country rating, which represents the average of the four clusters, are calculated by averaging these ratings. The ratings take into account a number of metrics, observations, and conclusions based on country expertise gained from within or outside the Bank as well as pertinent publicly available metrics.

Table 3. CPIA Criteria

Clusters	Economic Management	Structural Policies	Policies for Social Inclusion/Equity	Public Sector Management and Institutions
List of criteria	1. Monetary and Exchange Rate Policies 2. Fiscal Policy 3. Debt Policy and Management	1. Trade 2. Financial Sector 3. Business Regulatory Environment	1. Gender Equality 2. Equity of Public Resource Use 3. Building Human Resources 4. Social Protection and Labor 5. Policies and Institutions for Environmental Sustainability	1. Property Rights and Rule-based Governance 2. Quality of Budgetary and Financial Management 3. Efficiency of Revenue Mobilization 4. Quality of Public Administration 5. Transparency, Accountability, and Corruption in the Public Sector

⁷ <https://www.oecd-ilibrary.org/sites/9789264267213-7-en/index.html?itemId=/content/component/9789264267213-7-en>

The FCS classification in the World Bank methodology is used to identify countries affected by fragility and conflict. The classification is based on the following definitions and metrics⁸:

- **Fragility:** Fragility is defined as a systemic condition or situation characterized by an extremely low level of institutional and governance capacity which significantly impedes the state's ability to function effectively, maintain peace and foster economic and social development.

Countries/territories in a situation of Fragility are identified by the combination of the following indicators:

1) (a) the CPIA score for IDA countries (for which CPIA scores are disclosed) that is below 3.0; or (b) the presence of a UN peacekeeping operation; or (c) flight across borders of 2,000 or more per 100,000 population from the origin country or territory, who are internationally regarded as refugees in need of international protection; and

2) Those that are not in conflict (see methodology below), as such countries have gone beyond fragility.

- **Conflict:** Conflict is defined as a situation of acute insecurity driven by the use of deadly force by a group—including state forces, organized non-state groups, or other irregular entities—with a political purpose or motivation. Such force can be two-sided—involving engagement between multiple organized, armed sides, at times resulting in collateral civilian harm—or one-sided, in which a group specifically targets civilians.

Countries/territories in Conflict are identified by the combination of the following indicators:

1) Countries in ongoing conflict, as measured by (a) an absolute number of conflict deaths above 250 according to Armed Conflict Location & Event Data Project (ACLED) and 150 according to UCDP; and (b) above 2 per 100,000 population according to ACLED and above 1 according to UCDP; or

2) Countries with a rapid deterioration of the security situation, as measured by (a) an absolute number of conflict deaths above 250 according to ACLED and 150 according to Uppsala Conflict Data Project (UCDP); (b) between 1 and 2 (ACLED) and 0.5 and 1 (UCDP) per 100,000 population; and (c) more than a doubling of the number of casualties in the last year.

D. Other Measures

In addition to the indicators discussed above there are other measures that have been used to assess fragility or fragility related concepts.⁹ These include State Fragility Index (SFI), Index of State Weakness (ISW) and Failed States Index (FSI). While all of these measures were useful tools for assessing fragility, they are no longer produced or are not frequently used.

While fragility assessment may differ slightly depending on the index used due to variances in methodology or data sources used to inform these indices, comparing results from different indices have shown that they often yield overall similar rankings for countries considered most fragile and the deviations observed are usually in the intricate details and nuances.

The decision to utilize the States of Fragility dataset from OECD in this paper is primarily due to its detailed multi-dimensional and multi-aspect approach to gauging state fragility. It also offers a well-documented and exhaustive dataset with raw, unprocessed values from various indicators, making it ideal for quantitative analysis. As fragility is influenced by various factors including political, economic, social and environmental aspects, using an index like OECD approach that captures these diverse dimensions allows for a more sophisticated understanding of state fragility. Particularly, OECD's comprehensive approach to incorporating environmental issues into its measure of fragility is an advantage. Also, the OECD's two aspect method

⁸ <https://thedocs.worldbank.org/en/doc/fb0f93e8e3375803bce211ab1218ef2a-0090082023/original/Classification-of-Fragility-and-Conflict-Situations-FY24.pdf>

⁹ https://www.ilo.org/wcmsp5/groups/public/---ed_emp/documents/genericdocument/wcms_504533.pdf

considers coping capacities or resilience indicators, in addition to risk factors, in its assessment of fragility that distinguishes it from other indexes which primarily focus on risk factors. Overall, the extensive scope and detailed nuances of OECD's States of Fragility dataset offer an optimal foundation for advanced AI quantitative analysis.

III. AI Techniques to Explore Fragility-Related Data

A. Why Use AI and Machine Learning When Traditional Approaches Are Available?

Artificial intelligence (AI) aims to replicate human cognition in computer systems for real-world operation, while machine learning (ML) provides specific algorithms enabling computers to uncover insights, make decisions, and refine performance. Though distinct, AI and ML work symbiotically - ML delivers the technical mechanisms powering AI's goal of human-mimetic capabilities. Together, AI and its underlying ML components create versatile, adaptable systems that can analyze complex datasets, identify intricate patterns, and apply learnings to new situations. With fragility assessment, AI/ML provides key tools to model multifaceted relationships within data and generate nuanced, contextual insights.

In the context of fragility assessment, these techniques have been used primarily from the engineering, urban planning, health issues and environmental aspects rather than the economic definitions of it that we mentioned in this paper. For instance, AI and ML have been applied in the assessment of damage to historical buildings using imagery data from social media during disaster events (Zhang et al., 2022). In another example, AI and ML have also been used in the healthcare sector, such as in the prediction and diagnosis of COVID-19, demonstrating their potential in assessing fragility in a broader sense (Doğan et al., 2021; Borg et al., 2021; Ghayvat et al., 2022).

Deep learning and natural language processing, subsets of AI and ML, also hold potential in analyzing fragility. Deep learning, a type of ML, uses neural networks with many layers (hence, "deep") to learn complex patterns in large amounts of data. Natural language processing, on the other hand, allows computers to understand and interpret human language. These techniques could enhance the precision and efficiency of fragility assessments, although further research is needed to fully realize their potential.

Boelaert and Ollion (2018) offer an introduction and compare machine learning to more classical econometric approaches to quantification, including parametric regression. They argue that machine learning has several advantages over econometric models in terms of complexity and multifaceted contexts (like fragility which we study in this paper). Unlike traditional econometric models, machine learning models can process complex data structures, capture nonlinear variable relationships, and analyze large, multi-parameter datasets to uncover intricate patterns not readily visible to humans. However, machine learning still has limitations, mainly requiring thoughtful curation of training data to avoid perpetuating biases or overfitting noise. When applied carefully, machine learning provides valuable capabilities for disentangling elaborate interactions within expansive, real-world data. However, these flexible models need disciplined implementation to deliver meaningful, generalizable insights..

Traditional methods for analyzing fragility have limitations in capturing its complex nature. Techniques like linear regression usually make simplistic assumptions about variable relationships. They struggle to effectively manage high-dimensional, nonlinear datasets and identify long-term sequential patterns. In contrast, artificial intelligence and machine learning approaches provide a more robust framework for modeling fragility's intricacies. A key advantage of AI/ML is the ability to uncover nonlinear relationships within data using algorithms like neural networks and support vector machines. The flexibility to represent complex, real-world nonlinear interactions allows AI/ML to build more accurate fragility assessments. By avoiding oversimplification and leveraging predictive insights from nonlinear analysis, AI/ML can deliver enhanced understanding of multifactorial, dynamic fragility.

Traditional methods also struggle with large, high-dimensional datasets containing many variables. Capturing the intricacies between numerous variables can lead to the curse of dimensionality, and overfitting in legacy approaches like regression. In contrast, while suffering from some of these issues, AI/ML techniques are better-

equipped for analyzing complex, multi-parameter data. Algorithms including Support Vector Machines (SVM), random forests, and deep neural networks account for high dimensionality and variable interactions. This allows AI/ML models to deliver greater accuracy and reliability versus traditional methods when assessing large datasets with many parameters.

Another key advantage of AI/ML over traditional methods is the ability to learn from data rather than rely on rigid assumptions that can lead to inaccurate models. New techniques can adjust their parameters based on learnings from the data itself. This capability to develop insights organically from data, rather than impose human suppositions, enables AI/ML to create more accurate models than traditional methods that make prior assumptions about relationships within the data.

AI/ML techniques are better equipped than traditional methods to avoid overfitting and build robust models. Overfitting occurs when a model fits noise rather than the underlying data pattern. AI/ML uses regularization methods to reduce overfitting. These techniques are also less sensitive to outliers versus traditional methods. AI/ML can also leverage various ensemble techniques like bagging and boosting to minimize the impact of outliers. Additionally, AI/ML can utilize recurrent neural networks (RNN) and long short-term memory networks (LSTM) to remember long-term sequential patterns. By mitigating overfitting, outliers, and forgetting long-term dependencies, AI/ML delivers more accurate models than traditional methods. For a more detailed discussion on the advantages and limitation of AI/ML methods see Molina, M. & Garip, F. (2019), Athey, S. (2018), López de Prado, M. (2019), Liu, Y., & Xie, T. (2019), Iskhakov, F., Rust, J., & Schjerning, B. (2020).

In summary, complexity in studying fragility poses challenges for traditional methods' linear assumptions. In contrast, AI/ML techniques can identify nonlinear relationships and patterns in data to create more accurate fragility models. The ability to capture intricacies makes AI/ML better suited than traditional approaches for modeling the nuances of fragility arising from diverse interacting factors. On the other hand, fragility data and the datasets used to study it are often large and high-dimensional, making AI/ML techniques the best choice for accurately and reliably analyzing this data. Additionally, the noise and outliers found in fragility data are usually higher than normal due to the complexity of the concept, different shocks that can affect it, the heterogeneity of contexts, and the diversity of variables involved, hence AI/ML techniques can be used to reduce the effect of these outliers and ensure more reliable models. Finally, fragility data is often dynamic and can change over time due to different shocks, making it important to be able to understand long-term patterns.

B. AI Techniques for Classification and Dimension Reduction

As mentioned in previous sections, fragility is a multidimensional concept heavily influenced by socioeconomic and environmental factors, making analysis of related data challenging. Techniques including classification, dimension reduction, and topic modeling are useful for managing this complexity. By identifying patterns, surfacing relationships, and reducing dimensionality, these AI/ML methods can transform fragility data into a more coherent, tractable form.

Some of the most commonly used AI techniques for classification, dimension reduction, topic modeling and feature selection include 1) Support Vector Machines (SVMs) and Support Vector Clustering (SVC); 2) K-Nearest Neighbors (KNNs); and 3) Non-linear versions of Principal Component Analysis (NLPCA, KPCA). This also includes different classes of Artificial Neural Networks (ANNs) including: 1) Convolutional Neural Networks (CNNs); 2) Recurrent Neural Networks (RNNs) and Long Short-Term Memory Networks (LSTMs). This list could be extended to include Latent Dirichlet Allocation (LDA), Non-Negative Matrix Factorization (NMF), Deep Belief Networks (DBNs) and finally one of the most useful classes of the models which is Autoencoders. Each of these techniques has different strengths and weaknesses and can be used to analyze high-dimensional and large datasets typically used for fragility-related studies.

Evaluating ML/AI methodologies primarily hinges on a set of key criteria. Firstly, the accuracy and precision of the model is of vital importance. This involves measuring how closely the model's output aligns with the actual or expected results. Precision refers to the consistency of similar output in repeated trials. Another significant criterion is generalizability, or the model's ability to perform well not only on the training data but also on new, unseen data. This property can be assessed through cross-validation methods. Additionally, robustness is a crucial factor in determining a ML methodology's effectiveness. It measures the model's ability to maintain

performance even when subjected to small changes or errors in the input data. The complexity of the model is also a critical consideration; a simpler model that can achieve similar results as a complex one is typically preferred due to its interpretability and lower computational demands. Lastly, speed and efficiency are evaluated, which include both the training and prediction times. These aspects become increasingly important in real-time applications where high-speed results are required. For a detailed discussion on the criteria to select and compare ML/AI methods see Chauhan (2020), Makand (2020), Boyer (2021) in IBM Grage Methodology field guide and Gosho (2023).

In this study and as a case study of the ML/AI-driven approach to study fragility data we use a combination of statistical, machine learning and artificial intelligence techniques to address the fragility challenge. Specifically we focus on four main techniques, namely: 1) Support Vector Clustering (SVC); 2) Kernel Principal Component Analysis (KPCA); 3) Recurrent Neural Networks (RNNs); and finally 4) Long Short-Term Memory Networks (LSTMs). SVC is a type of unsupervised machine learning algorithm that can be used mainly for classification. SCV (like SVM which is a similar but supervised method) is highly effective in dealing with high-dimensional data, which is often found in fragility-related datasets. KPCA is a non-linear statistical/ML dimension reduction technique that can be used to reduce the complexity of the data and identify patterns in the data. RNNs and LSTMs are two types of deep learning and artificial intelligence algorithms that can be used to capture temporal patterns in the data and remember long-term patterns. RNNs are used for both classification and regression tasks while LSTMs are more suited for predicting outputs based on temporal data. All four of these techniques can be used to analyze fragility-related data and provide more accurate and reliable models.

This study uses KPCA for dimensionality reduction of the data, RNN and SVC for classification and LSTM for prediction. The data used for this exercise is the raw Fragility-related data collected by the OECD (use to build its States of Fragility index). But before going to the details, first some background information on the abovementioned methodologies used in this study is provided.

KPCA

Kernel Principal Component Analysis (KPCA) is a nonlinear dimensionality reduction technique that generalizes classical linear Principal Component Analysis (PCA). While PCA identifies the principal axes of variation in a linear subspace of the data, KPCA transforms the data nonlinearly into a higher dimensional feature space where it performs linear PCA. This enables KPCA to uncover nonlinear relationships and patterns that standard PCA cannot detect. By extending PCA to nonlinear spaces, KPCA provides more flexibility in reducing complex, real-world data to its most salient components.

KPCA leverages kernel functions to nonlinearly transform data into a high-dimensional feature space. This enables separation of patterns that are not linearly separable in the original input space. By extracting nonlinear relationships that would be hidden to linear techniques, KPCA can effectively reduce dimensionality while preserving essential data structure. This "kernel trick" gives KPCA flexible nonlinear modeling capabilities without the computational burden of explicitly mapping to an expanded feature space.

A basic representation of KPCA could be as follows:

$$KPCA(X) = K(X,X)W,$$

Where X is the input data matrix, K is the kernel function, and W is transformation matrix. The transformation matrix is calculated by solving the following eigenvalue problem:

$$KW = \lambda W,$$

Where λ is eigenvalues and W is the corresponding eigenvectors. The eigenvectors are used to project data points into a subspace of the original space and reduce the dimensionality of data.

SVC

Support Vector Clustering (SVC) is an unsupervised machine learning algorithm used to identify clusters within datasets. It stems from the supervised Support Vector Machine (SVM) algorithm and operates by maximizing intra-cluster point distances while minimizing inter-cluster separation. This is achieved by locating an optimal hyperplane that separates the data clusters.

The mathematical foundation of SVC is built on optimizing an objective function. This function comprises two terms: a separation term that measures inter-cluster distances, and a regularization term that penalizes model complexity. By balancing cluster separation against overfitting through this objective, SVC can delineate groupings that effectively capture structure within data.

A simple representation for objective function in an SVC can be formulated as follows:

$$L(w, b) = f(w) + \lambda R(w, b)$$

Where:

- w = weight vector
- b = bias
- $f(w)$ = the separation term or the sum of squared distances between data points and their respective clusters
- λ = regularization parameter
- $R(w, b)$ = the regularization term or the penalty term for violating the constraints on the hyperplane

SVC finds the optimal separating hyperplane by optimizing the objective function through algorithms like gradient descent. Data points are clustered based on their position relative to the hyperplane. This optimization occurs iteratively until the hyperplane converges on an ideal separation of the data. By solving for the boundary geometry that minimizes intra-cluster distances and maximizes inter-cluster divides, SVC reveals insights into a dataset's intrinsic structure.

The main advantage of SVC is that it can cluster nonlinear data, unlike linear separable methods. It also has lower computational complexity versus algorithms like K-means and hierarchical clustering. Additionally, SVC identifies varied cluster sizes and shapes, enabling broad applicability. These advantages in flexibility, efficiency, and applicability make SVC a versatile unsupervised learning technique for extracting insights from diverse datasets.

RNN

Recurrent neural networks (RNNs) are a type of artificial neural network well-suited for processing sequential data. RNNs contain cyclically connected neurons that pass information from one timestep to the next. This recurrent structure enables RNNs to retain memories from prior inputs when generating current outputs. The ability to preserve sequential dependencies makes RNNs ideal for modeling time-dependent patterns.

Technically, RNN neurons calculate weighted sums of inputs then pass through an activation function to produce outputs. The outputs are fed as inputs into the next neuron, allowing information to flow cyclically across time steps. Key memory units store relevant aspects of earlier inputs to inform future outputs. This architecture provides RNNs their distinctive memory and temporal processing capabilities.

Initially developed in the 1980s, RNNs gained prominence recently with computing advances enabling complex models. They now have diverse AI applications including time series forecasting, classification, natural language processing, and generative modeling. RNNs' sequential memory unlocks modeling opportunities for temporal data across machine learning domains. Their flexibility makes them a versatile tool for leveraging historical patterns to inform future predictions.

LSTM

Long Short-Term Memory (LSTM) is a type of RNN designed to model long-term dependencies in sequential data. LSTM has input, forget, and output gates that regulate information flow through memory cells. This gating mechanism allows LSTMs to preserve relevant past learnings across time steps while preventing older memories from being lost or overridden. The ability to retain selective information is key to LSTM's strengths in processing sequences with long-range continuities. (Figure 3).

Figure 3. RNN vs LSTM Architecture

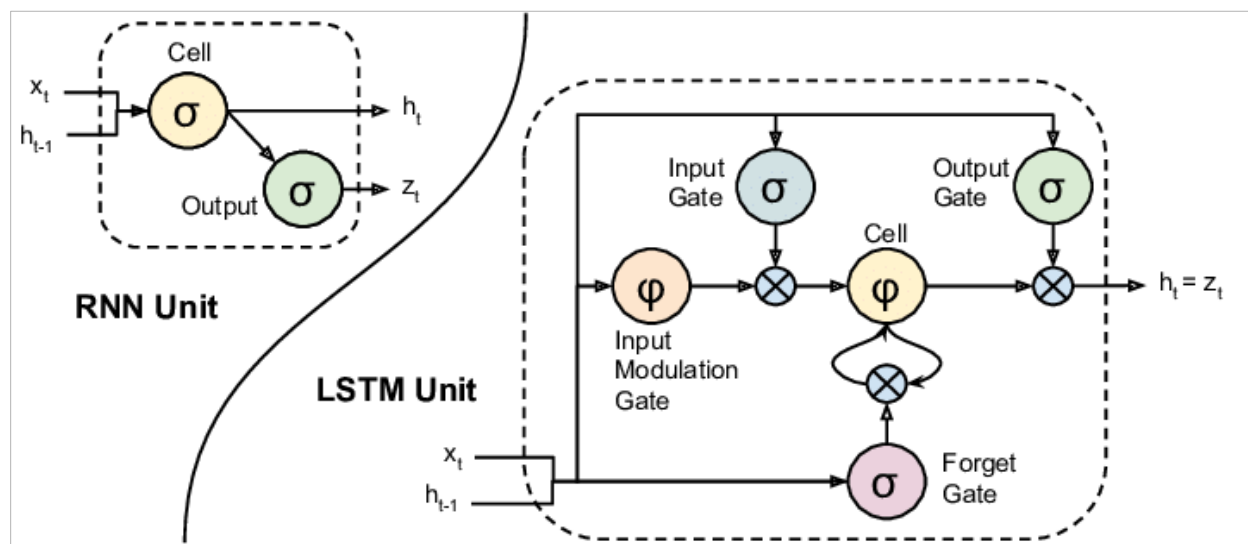

Source: (Donahue et al., 2014)

At a high level view, LSTM networks operate by using new input data to update the model's state representation. This state captures the current understanding of sequential relationships. The updated state is then used to make predictions for future time steps. As this process repeats, LSTMs build internal representations of long-term data dependencies.

As mentioned in the beginning, a key LSTM advantage is efficiently capturing long-term relationships within sequences. This makes them well-suited when past points affect future points. LSTMs also handle large datasets. These strengths come from selectively retaining relevant past information while forgetting non-essential memories.

All aspects of LSTM are twofold: LSTMs enable recognizing temporal patterns to improve prediction accuracy. They also model long-term data relationships to further enhance reliability. By learning sequential nuances, LSTMs allow models to make more contextual predictions from time-series data. This gated memory architecture fundamentally augments how AI systems interpret and leverage historical information.

C. Application to OECD Data

The Data

The OECD multidimensional fragility framework (States of fragility) is a measure of intensity across six dimensions: economic, environmental, human, political, security and societal. The framework uses 57 indicators across 6 mentioned dimensions for 176 countries. The selection of indicators is based on their relationship to fragility, looking at risk and coping capacity of countries. These indicators cover 99.5 percent of the world's population, including 100 percent of the population of sub-Saharan Africa, Middle East and North Africa, and South Asia. OECD uses this data. The OECD fragility framework uses an initial data collection stage and a two-stage process of traditional linear principal component analysis and a qualitative expert-knowledge-based hierarchical clustering to identify and group fragile contexts¹⁰. In our study, we use the data collected by the OECD Fragility Framework, but not the processed data resulting from its two-stage process. OECD collects its data from different sources, e.g., the World Bank's WDI, IMF, FAO, etc. A sample data of this dataset is shown in Table 4.

¹⁰ <http://www3.compareyourcountry.org/states-of-fragility/about/0/>

Table 4. A Sample Data from OECD's Fragility Dataset

	iso3c	year	variablename	value	imputed	dimension	type	doesmoreincreasefragility	include	source
61	AFG	2021.0	Access to basic water (C)	-75.09141	-75.09141	Human	Coping	0.0	1.0	WDI
123	AFG	2021.0	Access to immunisation services (C)	-70.00000	-70.00000	Human	Coping	0.0	1.0	WDI
185	AFG	2021.0	Access to justice (C)	-0.19700	-0.19700	Societal	Coping	0.0	1.0	V-DEM
247	AFG	2021.0	Adolescent birth rate (R)	57.50900	57.50900	Human	Risk	1.0	1.0	WDI
309	AFG	2021.0	Age dependency ratio (R)	80.08826	80.08826	Human	Risk	1.0	1.0	WDI
371	AFG	2021.0	Air quality (C)	-15.50000	-15.50000	Environmental	Coping	0.0	1.0	EPI
433	AFG	2021.0	Arrests from online political content (R)	2.16400	2.16400	Political	Risk	0.0	1.0	DSP
495	AFG	2021.0	Attitudes on violence against women (C)	80.20000	80.20000	Security	Coping	1.0	1.0	OECD
557	AFG	2021.0	Biodiversity and habitat (C)	-30.70000	-30.70000	Environmental	Coping	0.0	1.0	EPI
619	AFG	2021.0	Current account deficit (R)	15.59312	15.59312	Economic	Risk	0.0	1.0	WDI
681	AFG	2021.0	Debt-to-GDP ratio (R)	7.39700	7.39700	Economic	Risk	1.0	1.0	IMF
743	AFG	2021.0	Environment-related displacement (R)	62.75821	62.75821	Environmental	Risk	1.0	1.0	IDMC
805	AFG	2021.0	Exchange rate volatility (R)	0.04059	0.04059	Economic	Risk	1.0	1.0	IMF
867	AFG	2021.0	Exclusion by social group (R)	0.47400	0.47400	Societal	Risk	1.0	1.0	V-DEM
929	AFG	2021.0	Exposure to hazards (R)	6.70000	6.70000	Environmental	Risk	1.0	1.0	INFORM
991	AFG	2021.0	Financial inclusion (C)	-1.87000	-1.87000	Economic	Coping	0.0	1.0	WDI
1053	AFG	2021.0	Food supply adequacy (C)	-106.00000	-106.00000	Environmental	Coping	0.0	1.0	FAO

Source: OECD-prepared time series dataset of fragility-related indicators¹¹

The Method

In the first step, using scikit-learn (sklearn) machine learning libraries in Python for Kernel Principal Component Analysis and standard scaling, we performed a KPCA for each year in the years from 1979 to 2021 in the OECD collected data, to determine the aggregate fragility score for each country (a number between 1 and 100; 1 as least fragile and 100 as the most fragile). Additionally, we ranked the results based on the value of the eigenvalues produced in the KPCA for each year.

In the second step, we used a SVC model, from the same library, with a Polynomial kernel to classify countries based on their fragility score. The code reads in the data, splits the data into training and test sets, and then fits the model to the training data. It then predicts the values for the test data and generates a confusion matrix—to describe the performance of the model. Finally, we classified the countries based on the results.

We repeated the classification procedure using Recurrent Neural Networks (RNN) to see if we could detect any considerable changes or improvements. For the RNN we used Keras library. The RNN used in the study was composed of three fully connected layers, with the first two having 20 and 10 neurons respectively and the last layer having 6 neurons. It was optimized with the Adam optimizer, with a loss function of sparse categorical cross entropy and an accuracy metric. The activation functions for the first two layers were ReLU and the last layer was SoftMax.

Finally, we trained an LSTM—using Keras—to estimate the impact of each dimension on the aggregate fragility score as well as predict its value for one year ahead. We created a sequential LSTM model with 50 units and a relu activation, and a kernel regularizer of l2. The model was compiled with a mean squared error loss function and an adam optimizer.

For visualizing the results, we built a plotly Dash-based application to interactively explore (and compare) the results across different dimensions, countries and years.

One question that one can have is how our approach differs from the way the OECD processes the raw data and produces its results. The OECD method is, in principle, a combination of linear dimensionality reduction and expert-judgment clustering techniques, whereas the method used in this study is a non-linear

¹¹ <https://github.com/hdesaioecd/oecd-sof-2022-public/blob/main/cache/sfr.time.series.RData>

dimensionality reduction and unsupervised automated procedure. This is in addition to the general issues about the distinction between the traditional and new methods that were discussed in the previous sections. The results produced by the methods are to a large extent similar, with the exception of some changes in the rankings of the fragile countries—which cannot be interpreted or linked to the advantage or the weakness of the methods. While both methods may yield comparable overall findings, it is theoretically anticipated that newer methods, such as the method used in this study, are better able to better capture the nuance and non-linearities in the factors related to fragility, while the expert-judgement used by OECD might be more accurate in the clustering stage.

On the other hand, the automated procedure used in this study could be faster/easier-to-deploy and less costly than the OECD method. OECD updates its fragility indicators every two years. Newer methods could be useful in updating the fragility measures more frequently in a shorter period of time. Another (minor) methodological difference is that while the OECD project also does not provide a time-series for the fragility and its dimensions for the countries over time, this study does, as we can see in the following section.

The Results

Here we present some samples of the findings from the study. The application to produce the results is a dynamic dashboard, hence the data presented in this section is just a snapshot of the results. The users can play around with the dashboard to get more detailed insights about particular countries, dimensions, or years of interest.

As an example, we can see in Figure 4 that fragility in Syria has jumped in 2011–2012. This was mainly due to the outbreak of civil war and then the rise of militant groups such as ISIS. The conflict led to an increase in mass displacement, destruction of infrastructure, breakdown in healthcare and education systems, a rise in poverty and food insecurity, and political instability, all of which have contributed to the fragility in the country. Figure 5 delves deeper into the dynamics underlying this chart, demonstrating that, while there had been long-term sustained political fragility in the system prior to these events, and aggregate fragility was at low and stable levels, economic and societal fragilities began to rise a few years before the crisis. In particular, it clearly illustrates the dramatic increase in security fragility in Syria, which has been the key cause driving the deterioration in the aggregate fragility. It also shows that while the security fragility has been in elevated levels in recent years, relative improvements in economic and social fragility have resulted in a relative decrease in total fragility, albeit remaining high.

Figure 4. Fragility in Syria in the Last Decade

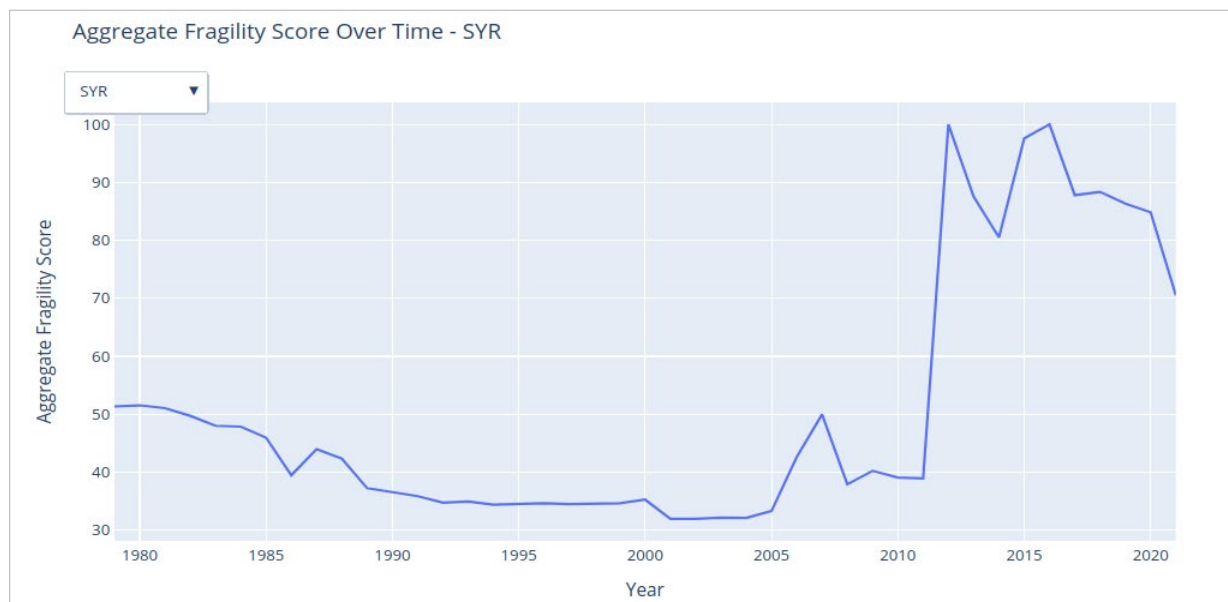

Source: Authors' calculations based on OECD dataset

Figure 5. Different Aspects of Fragility in Syria in the Last Decade

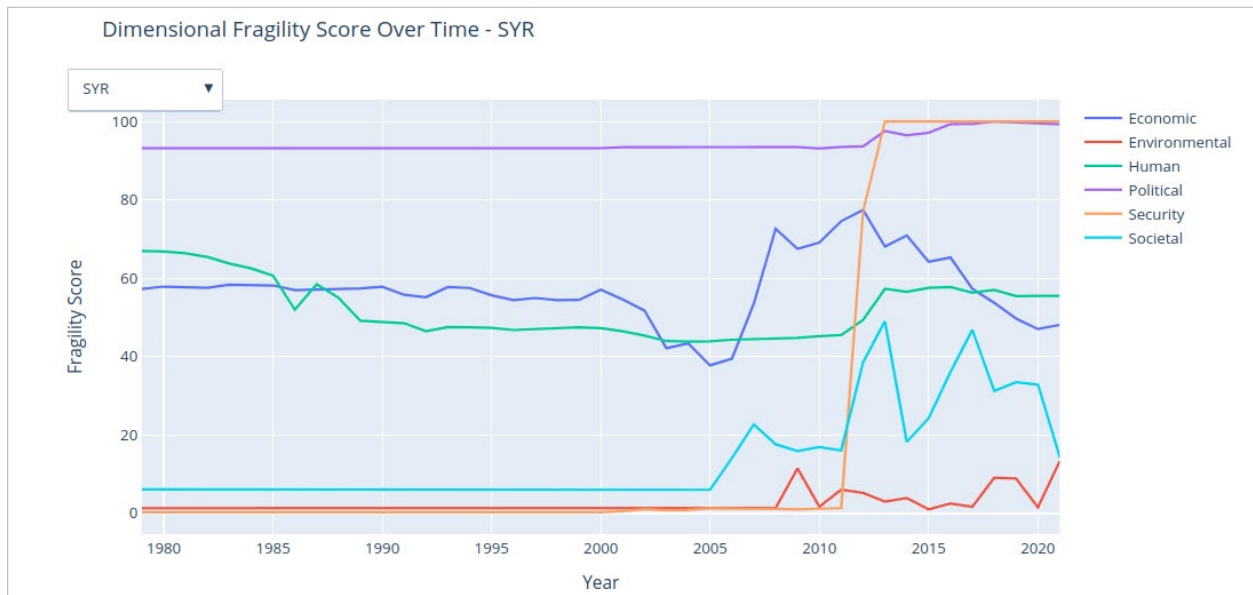

Source: *Ibid.*

In another example, Figure 6 shows a comparison of aggregate fragility between Haiti and Senegal. While the overall fragility in both countries seem to be at similar levels, we can see a jump for Haiti in 2010 and an increase for Senegal in 2009. But what happened in those years? Figure 8 may help to dig deeper into the details. Figure 7 shows that in both countries Environmental Fragility was at its highest level in recent decades in those years. But what happened at that time? In 2010, Haiti was hit by a major earthquake which caused extensive damage and destruction and in 2009, Senegal experienced severe floods, leading to a relative increase in fragility. These insights can help to understand the underlying drivers of fragility in countries and inform the focus of interventions or investments.

Figure 6. Fluctuation of Aggregate Fragility in Haiti and Senegal

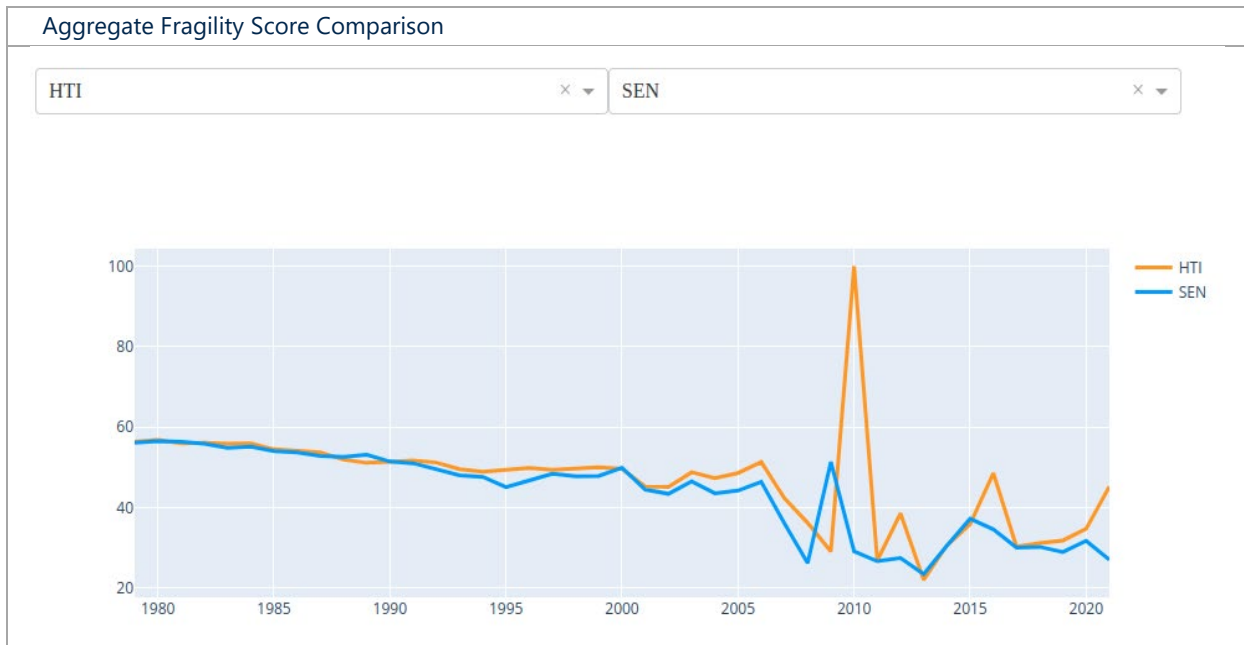

Source: *Ibid.*

Figure 7. Fluctuation of Fragility Dimensions in Haiti and Senegal

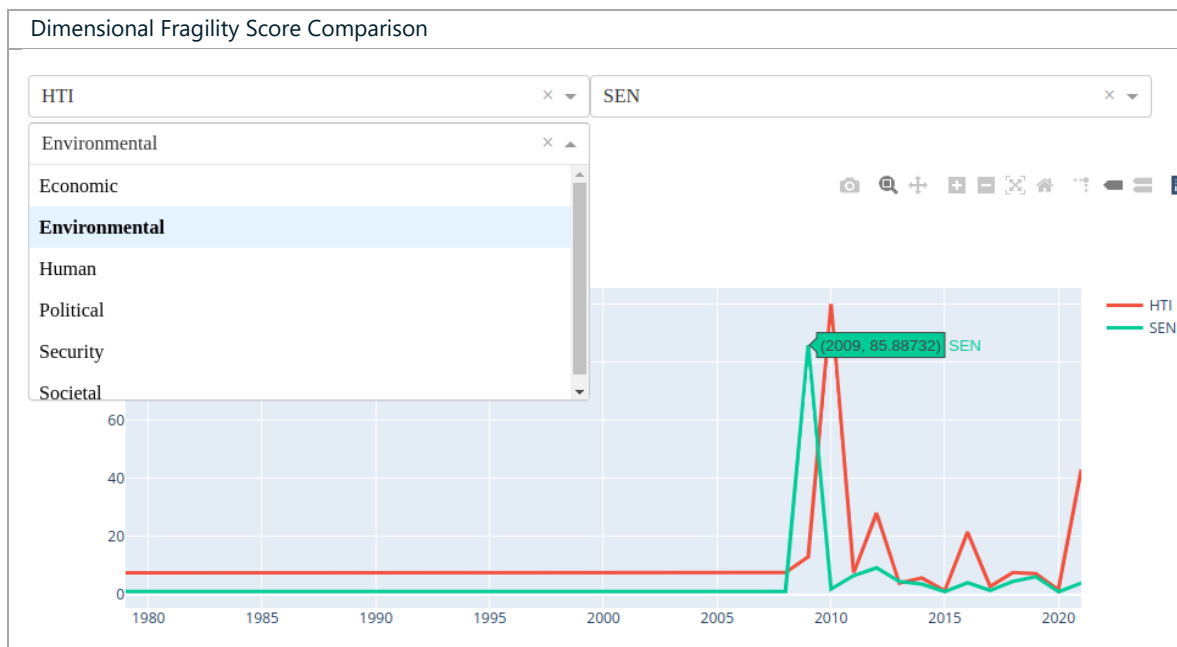

Source: *Ibid.*

In addition to comparing two or more countries, we can take a larger and global perspective to identify the most fragile countries. Table 5 displays the most fragile nations produced in our methodology. We can see that between 2020 and 2021, South Sudan had the highest level of fragility for 4 years, followed by Somalia, Syria, and the Central African Republic for 2 years each.

Table 5. Most Fragile Countries (2010–2021)

Rank	2010	2011	2012	2013	2014	2015	2016	2017	2018	2019	2020	2021
1	HTI	PSE	SYR	CAF	SSD	CAF	SYR	SOM	SOM	SSD	SSD	SSD
2	SOM	SOM	SSD	SYR	CAF	SYR	SSD	CAF	CAF	CAF	SOM	CAF
3	COL	BTN	SOM	SOM	SYR	VUT	CAF	SSD	SYR	SOM	CAF	SOM
4	PSE	SSD	PSE	PSE	SOM	SSD	SOM	SYR	SSD	SYR	SYR	SYR
5	AFG	AFG	TCD	SSD	PSE	SOM	TCD	TCD	PSE	TCD	VUT	COD
6	CAF	SDN	CAF	SDN	TCD	YEM	PSE	CUB	AFG	NER	NER	TCD
7	PAK	ERI	SDN	TCD	SDN	TCD	NER	NER	TCD	COG	TCD	NER
8	CHL	JOR	AFG	JOR	IRQ	PSE	ERI	PSE	NER	PSE	HND	SDN
9	TCD	CAF	NER	PHL	ERI	NPL	AFG	COD	COD	MOZ	COD	PSE
10	ERI	IRQ	ERI	ERI	NER	ERI	CUB	ERI	SDN	SDN	SDN	YEM

Source: *Ibid.*

As another example of how the fragility data could be further explored, a look at the distribution of the fragility (Figure 8) at the aggregate level shows that while the majority of countries have a low or limited levels of fragility, a not so small club of countries also suffer from high levels of fragility. Figure 9 (a box plot) might give more insight as it shows that political, economic and human fragility seem to have affected larger numbers of countries.

Figure 8. Box Plot of Aggregate Fragility in 2021

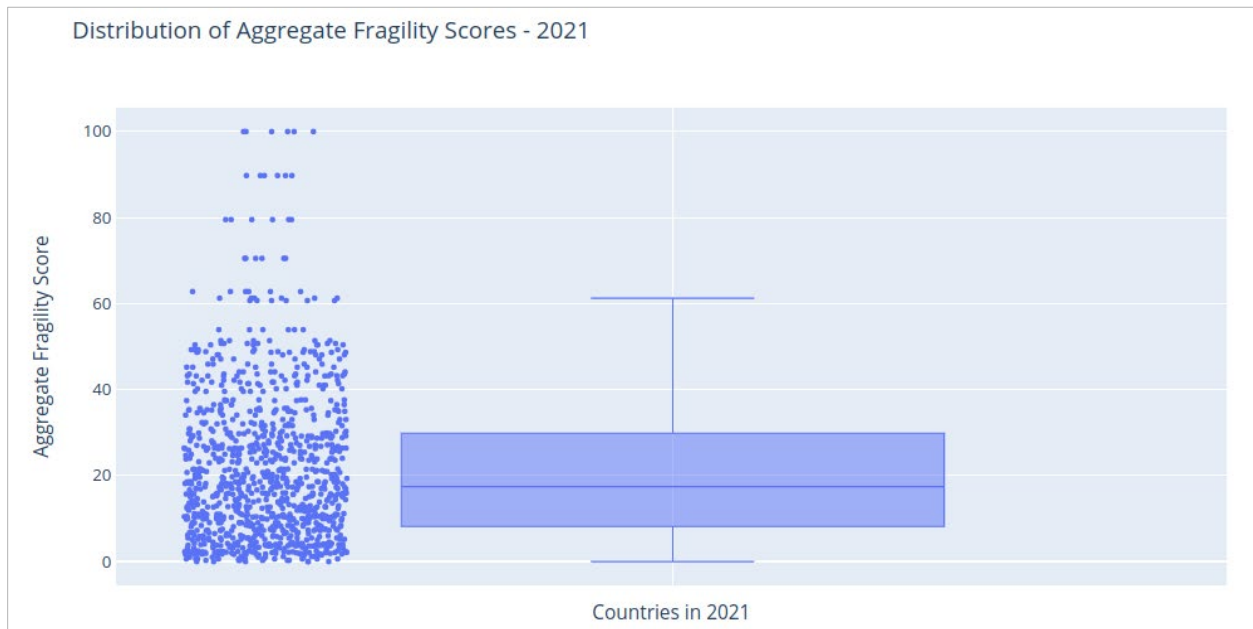

Source: *Ibid.*

Figure 9 highlights the economic and human dimensions as being positioned somewhere in the middle. This finding implies that these dimensions hold significant importance, underscoring the need to address them comprehensively.

Figure 9. Box Plot of Dimensional Fragilities in 2021



Source: *Ibid.*

As another example, one might be interested to look at the most fragile countries in specific aspects of fragility. Figure 10 is an example of such an application. We can see that the Philippines, South Sudan and Haiti have been the most environmentally fragile countries in 2021. In this year, in the Philippines, Super Typhoons Kiko and Odette caused severe disruptions in many areas. In South Sudan, two-thirds of the country was

experiencing historic flooding, and in Haiti, a M7.2 earthquake struck parts of the country and it also experienced a direct hit from Tropical Depression Grace.

Figure 10. Most Environmentally-Fragile Countries in 2021

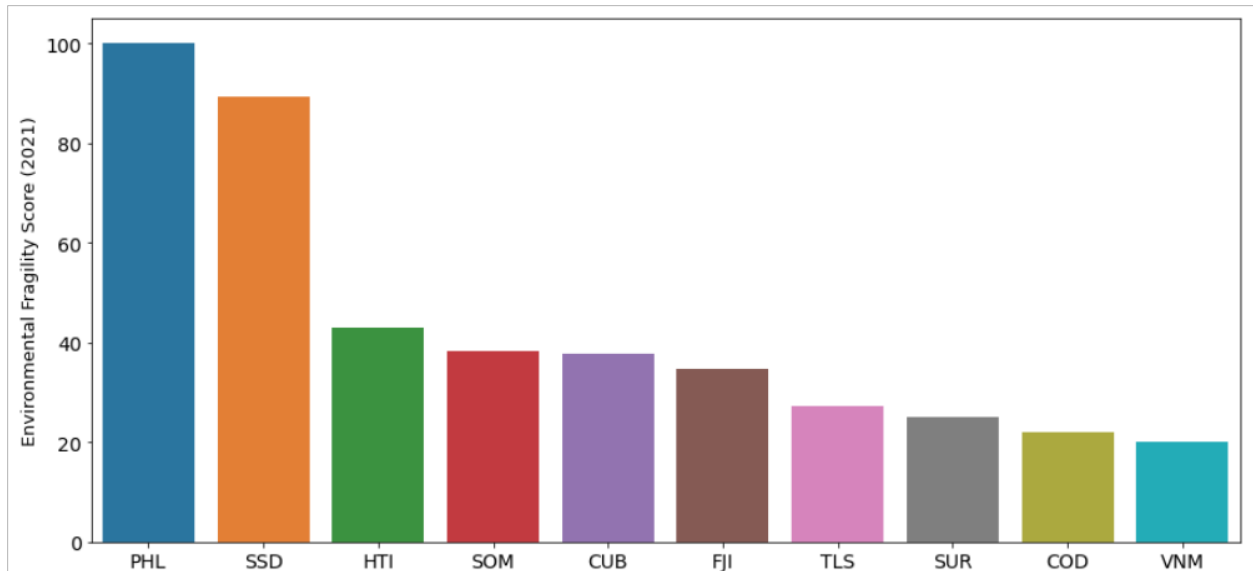

Source: *Ibid.*

The distribution of aggregate or dimensional fragilities across time can be used to track the overall trends in fragility. Figures 11 through 13 depict examples of such views.

Figure 11. Box Plot of Aggregate Fragility 2010–2021

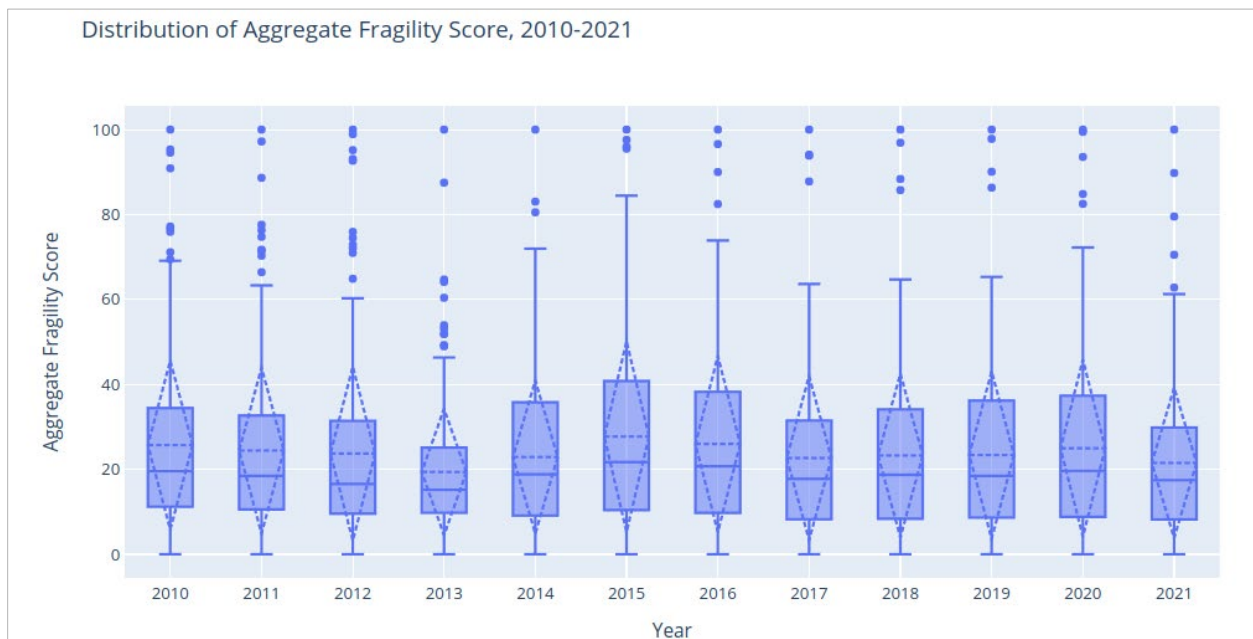

Source: *Ibid.*

Figure 12 suggests a decrease in economic fragility across nations, although additional evidence is required to support this claim.

Figure 12. Box Plot of Economic Fragility 2010–2021



Source: *Ibid.*

Figure 13. Box Plot of Environmental Fragility 2010–2021

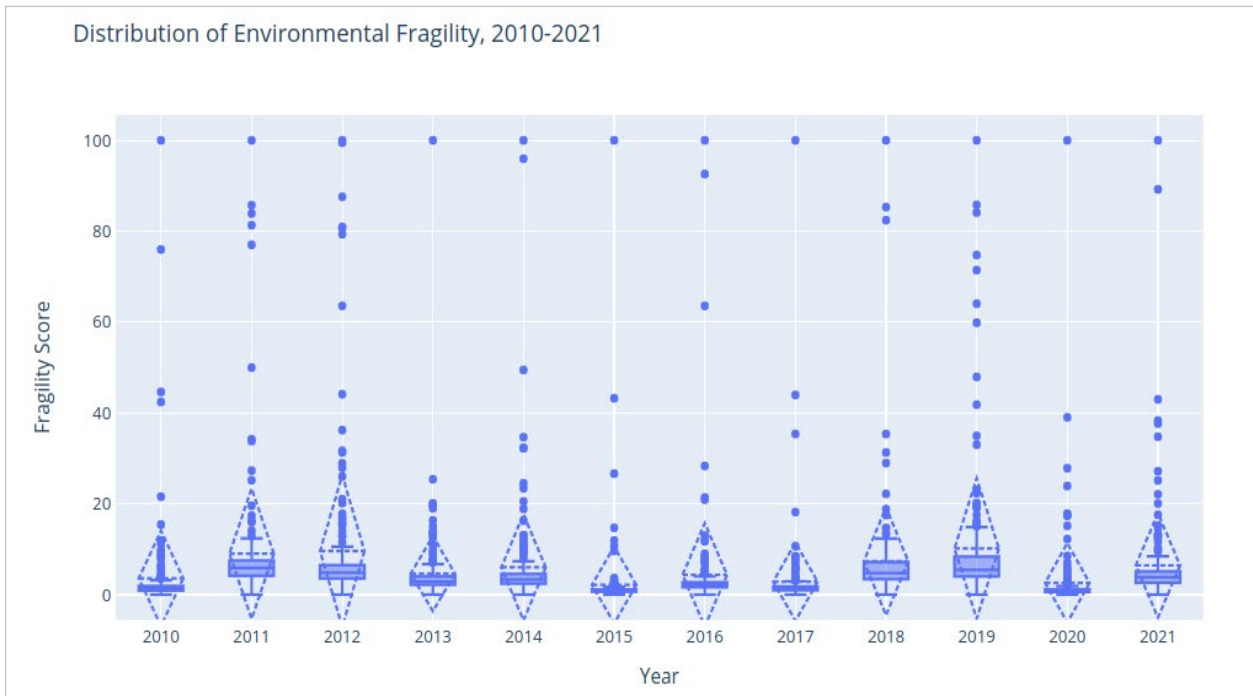

Source: *Ibid.*

IV. The Case of South Sudan

A. History and Background

South Sudan, the world's newest country, declared independence in 2011, but has since been beset by external and domestic conflicts. In studying the situation in South Sudan, it is crucial to consider the prevailing conditions before independence, as Sudan was an FCS and South Sudan was 'born fragile' rather than becoming fragile. South Sudan's oil production was temporarily halted due to a brief war with Sudan in 2012 over disputed oil reserves and oil transit fees, resulting in a significant reduction in real GDP. A power struggle between President Kiir and Vice President Machar in 2013 sparked a civil war that killed hundreds of thousands, displaced 1.5 million internally, and sent over 2 million refugees to neighboring countries. South Sudan's economic and social indicators, which were already among the lowest in the world at the time of independence, have worsened considerably during the last decade.

Since April 2021, reforms implemented under an IMF Staff-Monitored Program (SMP) have contributed to some improvements in macroeconomic stability. South Sudan graduated from SMP in March 2023 and began a SMP with the board involvement (PMB) with the IMF. However, given South Sudan's unstable economy and politics, the durability of these advances is not guaranteed. Due to violent war, widespread poverty, and poor institutions, South Sudan faces numerous hurdles in attaining long-term stability, inclusive growth, and human capital development.

South Sudan is currently facing a "fragility trap" with interlocking sources of state fragility. An overly centralized state with limited legitimacy and checks on the executive branch, rent extraction by the political elite and vested interests, conflict over resources, and a large security sector/incomplete demobilization from the civil war are some prominent factors. Other factors include the legacy of a fraught independence from Sudan, weak public financial management, an economy over-reliant on oil, a large displaced population, and increasing exposure to climate shocks.

Fragility has had an immense human and economic toll, resulting in localized violent conflicts and poor private-sector economic activity. The country has accumulated public debts in the form of non-concessionary oil advances and has experienced high inflation. South Sudan is far from meeting the United Nations Sustainable Development Goals, ranking 164 out of 165 countries. Progress towards these goals will require an end to violent conflict, a diversified economic base, investment in infrastructure and human capital, and institutions that provide more equitable access to the country's resources. The PMB with the IMF aims to support the country's efforts to tackle these challenges and achieve economic stability and development.

B. Pillars of the Fund's South Sudan CES to Tackle Fragility

The IMF's South Sudan Country Engagement Strategy (CES), which was first published as part of the Staff Report for South Sudan's 2022 Article IV¹², aims to address fragility through short-term, medium-term, and long-term measures focusing on various developmental goals. These measures are designed to work alongside South Sudan's authorities, civil society, and other development partners. In the short-term, the IMF is targeting measures to restore credibility and macroeconomic stability to ensure stable prices and sustainable economic growth, building economic resilience and increasing the confidence of international donors and private investors.

Medium-term measures focus on improving social cohesion, political checks and balances, and igniting economic growth. Key objectives include increased agricultural productivity, protecting and enhancing social spending, fostering private-sector development, and economic diversification. Additionally, the Fund aims to

¹² <https://www.imf.org/en/Publications/CR/Issues/2022/08/03/Republic-of-South-Sudan-2022-Article-IV-Consultation-And-Second-Review-Under-The-Staff-521692>

support institutional development and change to increase accountability, deconcentrate political power, and tackle corruption risks while enhancing transparency in the oil sector.

Lastly the strategy has a long-term outlook with an emphasis on creating a diversified and inclusive economy. This approach includes measures such as strengthening property rights, restoring state's monopoly on security, and supporting South Sudan's integration into regional economic groups. IMF aims to balance short-term progress that builds legitimacy with transformational change in the long run, seizing opportunities to guide reforms and create space for longer-term reform agendas driven by South Sudan's authorities, civil society, and other development partners.

C. Findings from this Analysis

Analyzing the results produced by the methodology employed in this paper for South Sudan, it is clear that examining the country's fragility through various dimensional aspects helps to reveal its underlying causes. Figures 14, 15, and 16 provide some insight into South Sudan's aggregate fragility over time and the correlation of dimensional fragilities in 2021. By examining these figures, one can gain a deeper understanding of the various facets of fragility in South Sudan, allowing for more targeted interventions and support.

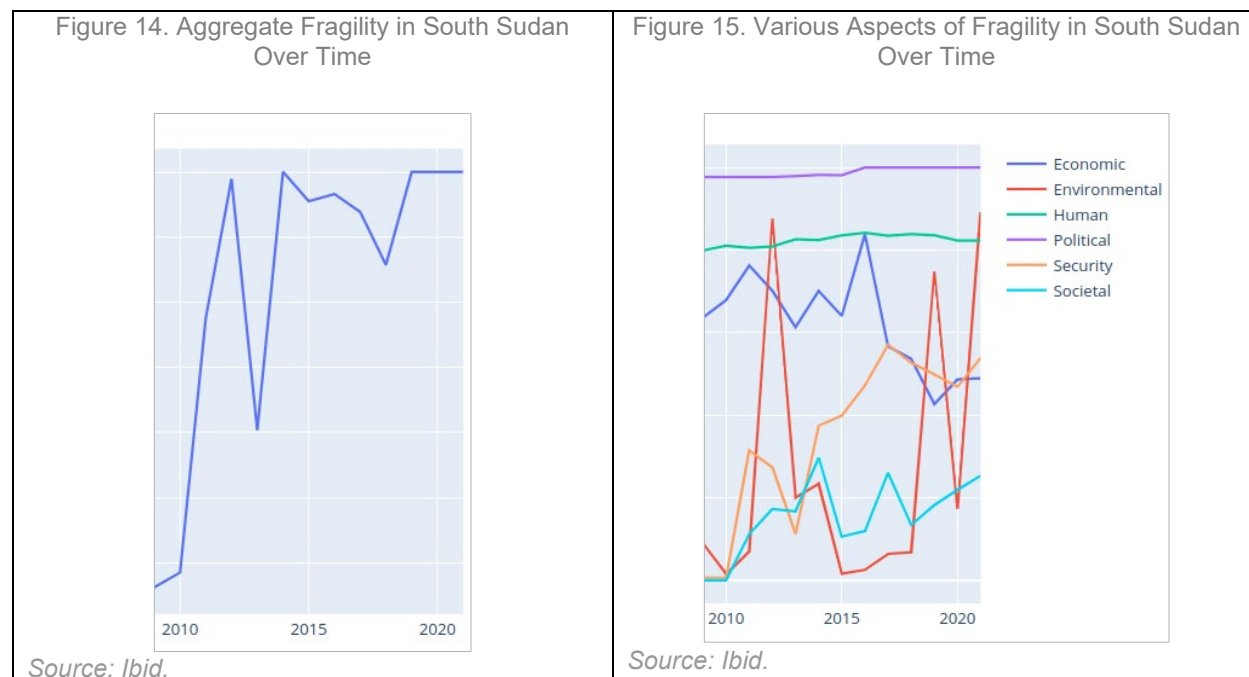

The results also indicate that political fragility significantly contribute to South Sudan's overall fragility. An examination of the fragility dynamics over time shows that political fragility has remained consistently high since the country's inception, while environmental issues such as flooding or drought have exacerbated the situation in certain years. Although human conditions have been dire nearly every year, there has been an improvement in economic fragility since 2016–2017. The analysis also indicates a high correlation between the uncertain security environment in the country and its overall fragility.

Figure 16 demonstrates a significant correlation between security, societal, and political fragility, and the overall level of fragility. Moreover, the figure reveals a strong correlation between societal and political fragility with security fragility. This could imply and investigated by further analysis that an increase in levels of security or political fragility (as is typical in South Sudan since its independence) will consequently impact other aspects of fragility, ultimately leading to higher overall fragility.

Figure 16. Heatmap of Correlation of Dimensional Fragilities for South Sudan in 2021



Source: *Ibid.*

A closer look at the various aspects of political fragility (Figure 17) in South Sudan also reveals a troubling trend. Apart from women's political empowerment, other sub-indicators of political fragility—both risk and coping/resilience-related components—have remained at elevated levels in recent years with no clear improvements observed. This consistently high level of political fragility suggests that the country is struggling to establish a stable and inclusive political environment, which, in turn, has far-reaching consequences for its overall fragility. The lack of progress in addressing these essential political issues highlights the need for a more concerted effort from both domestic and international stakeholders to support South Sudan in overcoming these challenges and fostering a more resilient and secure future.

Figure 17. Risk and Coping Political Fragility Sub-Indicators for South Sudan

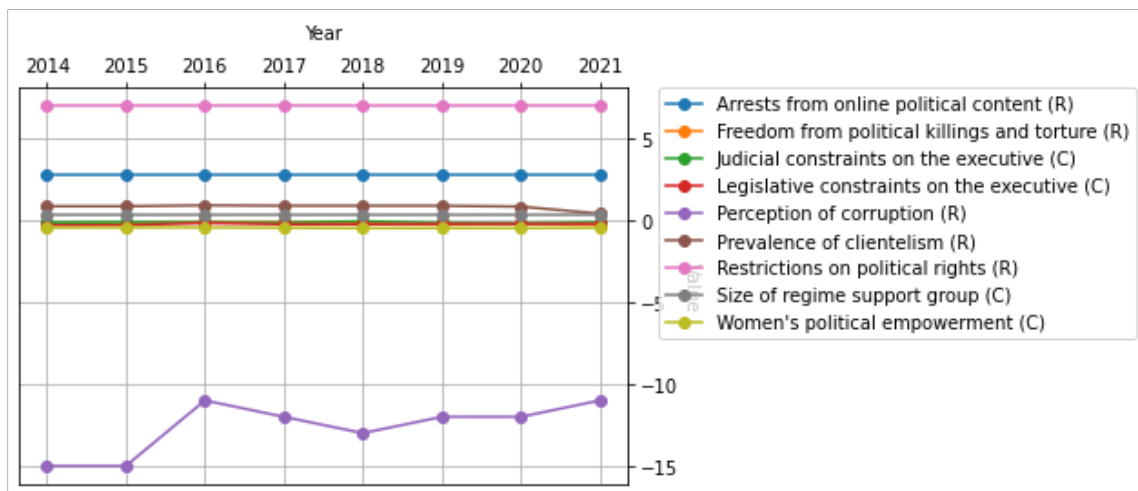

Source: *Ibid.*

The findings indicate that in order to mitigate the fragility of South Sudan, it is important to acknowledge the complex contexts contributing to the country’s political and security issues. This highlights the need for a sustainable governance strategy that not only tackles the root causes of conflicts but also acknowledges the

challenges associated with addressing political and security issues. Such a strategy should prioritize inclusivity and dialogue among different groups. On the economic front, achieving macroeconomic stability requires comprehensive economic and public finance reforms, as well as investments in infrastructure and improved agricultural techniques.. Furthermore, on the environmental side, investments in adaptation and resilience should be made to help the country become more resistant to the effects of climate change.

D. Implications from this Study to the Fund's South Sudan CES

The findings of this report could provide valuable insights for the CES, emphasizing the importance of a multi-dimensional and context-specific approach in addressing the root causes of fragility in South Sudan. Fund engagement should be anchored by its mandate, focusing on reducing fragility risks while also addressing macro-critical issues. In this regard, a key lesson from this report is the need to tailor interventions and support towards the most critical and pressing aspects of fragility in the country, namely political and environmental fragility. By prioritizing these areas, the CES could potentially have a more significant impact in mitigating the overall fragility of South Sudan. This could involve placing greater emphasis on supporting the establishment of a stable and inclusive political environment while promoting climate-resilient strategies that help the country become more resistant to the impacts of climate change.

Another lesson that could be drawn is the importance of continuous monitoring and analysis of South Sudan's fragility dynamics to ensure that the CES remains relevant and adaptive to the country's evolving needs and challenges. By embedding continuous monitoring using the AI approach in regular engagement, such as periodic program reviews, the CES could better track correlations between different dimensions of fragility and assess progress within these areas. This would enable the CES to better target its interventions and allocate resources effectively, ensuring that its goals and objectives stay pertinent to the country's current situation..

Furthermore, the report's findings could also encourage the IMF and other development partners to engage in ongoing dialogue and collaboration, ensuring that efforts in various fragility dimensions and related indicators are harmonized and complementary to foster greater resilience and security for South Sudan's future. Close coordination between different stakeholders is crucial to avoid overlapping or redundant initiatives while maximizing the potential impact of their collective efforts. By encouraging information sharing about fragility indicators, joint planning, and leveraging the strengths of various partners, the next improved versions of CES and the plans or engagements based on it can foster a more cohesive approach that addresses the diverse and interconnected challenges facing South Sudan on its path towards sustainable peace and development.

Reviewing the key findings of this research, it's noticeable how intensely fragility pervades across the multifaceted arenas of South Sudan's socio-political and environmental dimensions. Emphasizing political and environmental fragilities, the research corroborates the critical need for sustainable governance and climate-resilient strategies. A tailored intervention encapsulating these vital aspects of fragility could potentially yield more prominent impacts curbing the overall fragility. Furthermore, it emphasizes the necessity for cyclic monitoring and evaluation of South Sudan's fragility dynamics, ensuring that strategic interventions remain pertinent and tailored to South Sudan's fluctuating needs and challenges. Reflecting these overarching implications could significantly elevate the impact of the IMF's Country Engagement Strategy and international efforts, ensuring optimized resource allocation in alleviating the most severe fragility crises of nations akin to South Sudan.

V. Summary and Policy Discussion

Fragility is an essential and complex concept with significant implications for countries' stability, development and resilience. This study offers several important contributions. Firstly, it supports the growing consensus on the importance of adopting a multidimensional approach towards understanding state fragility. Our results corroborate the multifaceted nature of state fragility and highlight the need to consider various factors and dimensions when designing interventions and policy measures. This reinforces the argument that a nuanced, context-specific understanding of state fragility is crucial to devise effective solutions.

Secondly, our research demonstrates the utility of AI and ML techniques in fragility studies. By applying these advanced methods to fragility-related data, policy makers will be able to capture complex, nonlinear relationships between various aspects of fragility. This suggests that AI and ML techniques can provide a more comprehensive and detailed evaluation of state fragility compared to traditional approaches. Our findings indicate that these advanced tools can offer significant value in terms of improving both reliability and accuracy of fragility assessments.

Moreover, our application of ML and AI techniques also shows an improvement over expert policy judgment in terms of speed, cost-effectiveness, and adaptability. These tools can facilitate more rapid updates to fragility measures, thus enabling policymakers to respond faster to dynamic changes in state fragility.

Finally, our study underscores the potential of using unsupervised data techniques in policymaking. By employing unsupervised learning algorithms such as Support Vector Clustering (SVC) and Kernel Principal Component Analysis (KPCA), we were able to identify specific dimensions and sub-indicators that contribute to state fragility – insights that may not be readily apparent through expert judgment alone.

In conclusion, our research exemplifies the benefits of integrating advanced data techniques into policy discussions on state fragility. We believe these insights could help inform the design and implementation of more effective interventions aimed at mitigating state fragility.

Our application of these techniques to OECD fragility data has yielded insights into fragility trends at the global and country levels. Our findings corroborate the overall fragility patterns identified by the OECD but offer additional insights into the dynamics and drivers underlying these patterns. We applied the methodology to South Sudan, one of the most fragile countries in the world. The results highlighted the critical role of political and environmental fragility in driving overall fragility in the country. By addressing these specific dimensions, tailored approaches and interventions can be designed to foster resilience and mitigate the impacts of fragility. This understanding can inform the IMF's Country Engagement Strategy and other international efforts, ensuring that support and resources are effectively targeted at the most pressing fragility challenges faced by countries such as South Sudan.

References

- Acemoglu, D. and Robinson, J. A. (2019). Rents and Economic Development: The Perspective of Why Nations Fail. *Public Choice*, 181, 13–28.
- Acemoglu, D. and Robinson, J. A. (2021). Culture, Institutions and Social Equilibria: A Framework. (No. w28832). National Bureau of Economic Research.
- Akanbi, O. A., Gueorguiev, N., Honda, M. J., Mehta, P., Moriyama, M. K., Primus, K., and Sy, M. (2021). Avoid a Fall or Fly Again: Turning Points of State Fragility. Washington, D.C.: International Monetary Fund.
- Andrimihaja, N. A., Cinyabuguma, M. M., and Devarajan, S. (2011). Avoiding the Fragility Trap in Africa. *World Bank Policy Research Working Paper*, (5884).
- Athey, S. (2018). The Impact of Machine Learning on Economics. *In the Economics of Artificial Intelligence: An Agenda* (pp. 507–547). University of Chicago Press.
- Besley, T. and Mueller, H. (2020). Revenue Mobilization and State Fragility. *Macroeconomic Policy in Fragile States*.
- Besley, T., Ilzetzki, E. and Persson, T. (2013). Weak States and Steady States: The Dynamics of Fiscal Capacity. *American Economic Journal: Macroeconomics*, 5(4), 205–235.
- Borg, M., Bronson, J., Christensson, L., Olsson, F., Lennartsson, O., Sonnsjö, E., ... and Karsberg, M. (2021, June). Exploring the Assessment List for Trustworthy AI in the Context of Advanced Driver-Assistance Systems. In *2021 IEEE/ACM 2nd International Workshop on Ethics in Software Engineering Research and Practice (SEthics)* (pp. 5-12). IEEE.
- Boyer, Jerome. (2021), Evaluating and Selecting a Machine Learning Algorithm, *IBM Gragae Methodology*, www.ibm.com/garage/method/practices/reason/evaluate-and-select-machine-learning-algorithm. Accessed 16 July 2023.
- Carment, D., Prest, S., and Samy, Y. (2011). The Causes and Measurement of State Fragility. *Fragile states: Causes, Costs, and Responses*, 43–67.
- Carment, D., Samy, Y., and Prest, S. (2008). State Fragility and Implications for Aid Allocation: An Empirical Analysis. *Conflict Management and Peace Science*, 25(4), 349–373.
- Caselli, F. G., Presbitero, A. F., Chami, R., Espinoza, R., and Montiel, P. J. (2021). Aid Effectiveness in Fragile States. *Macroeconomic Policy in Fragile States*, 493–520.
- Chami, R. and Espinoza, R. (2021) Macroeconomic Policy in Fragile and Conflict-Affected States, IMF Internal Training.
- Chami, R., Espinoza, R., and Montiel, P. J. (Eds.). (2021). *Macroeconomic Policy in Fragile States*. Oxford University Press.
- Chauhan, Nagesh Singh. (2020). Model Evaluation Metrics in Machine Learning—KDnuggets. *KDnuggets*, www.kdnuggets.com/model-evaluation-metrics-in-machine-learning.html.
- Collier, P. (2018). *The Struggle for South Sudan: Challenges of Security and State Formation*. Bloomsbury Publishing.
- Collier, P. (2019). *Fixing Fragility: The Role of the Private Sector and Local Institutions*.

- Collier, P. and Venables, A. J. (2010). Natural Resources and State Fragility.
- Collier, Paul. (2020). Governance. Operating in a Fragile Environment. IMF Internal Training.
- Collier, Paul. Transition Programs: A Theory of the Scaffolding Needed to Build out of Fragility', in Ralph Chami, Raphael Espinoza, and Peter J. Montiel (eds), *Macroeconomic Policy in Fragile States* (2021; online edition, Oxford Academic, 18 Feb. 2021), Oxford Academic.
- Diallo, O., Loris Gui-Diby, S., and Imam, P. A. (2022). Do Monetary Policy Outcomes Promote Stability in Fragile Settings?
- Dogan, O., Tiwari, S., Jabbar, M. A., and Guggari, S. (2021). A Systematic Review on AI/ML Approaches Against COVID-19 Outbreak. *Complex & Intelligent Systems*, 7, 2655–2678.
- Feeny, S., Posso, A., and Regan-Beasley, J. (2015). Handle With Care: Fragile States and the Determinants of Fragility. *Applied Economics*, 47(11), 1073–1085.
- Gelbard, M. E., Deléchat, C., Fuli, M. E., Hussain, M. M., Jacoby, M. U., Glaser, M. D., ... and Xu, R. (2015). Building Resilience in Sub-Saharan Africa's Fragile States. Washington, D.C.: International Monetary Fund.
- Ghayvat, H., Awais, M., Bashir, A. K., Pandya, S., Zuhair, M., Rashid, M., and Nebhen, J. (2023). AI-Enabled Radiologist in the Loop. *Neural Computing and Applications*, 35(20), 14591-1460.
- Ghosh, Samadrita. "The Ultimate Guide to Evaluation and Selection of Models in Machine Learning". *Neptune.ai*, 21 July 2022, neptune.ai/blog/ml-model-evaluation-and-selection.
- International Monetary Fund, 2008, "The Fund's Engagement in Fragile States and Post-Conflict Countries—A Review of Experience—Issues and Options", Washington, D.C.: International Monetary Fund.
- International Monetary Fund, 2012, "Staff Guidance Note on the Fund's Engagement with Countries in Fragile Situations," Washington, D.C.: International Monetary Fund.
- International Monetary Fund, 2015, "IMF Engagement with Countries in Post-Conflict and Fragile Situations—Stocktaking," Washington, D.C.: International Monetary Fund.
- International Monetary Fund, 2022, "The IMF Strategy for Fragile and Conflict-Affected States," Washington, D.C.: International Monetary Fund.
- International Monetary Fund, 2023, "Staff Guidance Note on the Implementation of the IMF Strategy for Fragile and Conflict-Affected States," Washington, D.C.: International Monetary Fund.
- International Growth Centre (IGC), (2018). Escaping the Fragility Trap. The LSE-Oxford Commission on State Fragility, Growth and Development.
- Iskhakov, F., Rust, J., and Schjerning, B. (2020). Machine Learning and Structural Econometrics: Contrasts and Synergies. *The Econometrics Journal*, 23(3), S81–S124.
- Liu, Y. and Xie, T. (2019). Machine Learning Versus Econometrics: Prediction of Box Office. *Applied Economics Letters*, 26(2), 124–130.
- López de Prado, M. (2019). Beyond Econometrics: A Roadmap Towards Financial Machine Learning. *Available at SSRN 3365282*.
- Mankad, Sahil. "A Tour of Evaluation Metrics for Machine Learning." *Analytics Vidhya*, 24 Nov. 2020, www.analyticsvidhya.com/blog/2020/11/a-tour-of-evaluation-metrics-for-machine-learning.

- Milante, G. and Woolcock, M. (2017). New Approaches to Identifying State Fragility. *of Globalization and Development*, 8(1).
- Molina, M. and Garip, F. (2019). Machine Learning for Sociology. *Annual Review of Sociology*, 45, 27–45.
- Sacchetto, C., Logan, S., Collier, P., and Kriticos, S. (2021). Strengthening Development Finance in Fragile Contexts.
- Vallings, C. and Moreno-Torres, M. (2005). Drivers of Fragility: What Makes States Fragile? (No. 668-2016-45529).
- Zhang, Y., Zong, R., Kou, Z., Shang, L., and Wang, D. (2021). Collab-Learn: An Uncertainty-Aware Crowd-AI Collaboration System for Cultural Heritage Damage Assessment. *IEEE Transactions on Computational Social Systems*, 9(5), 1515–1529.



PUBLICATIONS

How Nations Become Fragile: an AI-Augmented Bird's-Eye View (With a Case Study of South Sudan)
Working Paper No. WP/2023/167